



## AFX FX-50 INTERNATIONAL OWNER'S MANUAL



**WARNING!** For your safety, it is important that you completely read the owner's manual and all warning labels.

**ADVERTENCIA!** Para su seguridad, es importante que vd., lea completamente el manual y todas las etiquetas de advertencias.

**ATT ENZIONE!** Per la tua sicurezza è importante che tu legga interamente ed attentamente questo manuale d'uso.

**ACHTUNG!** Im Interesse Ihrer eigenen Sicherheit empfehlen wir Ihnen, diese Benutzerhinweise und alle Sicherheitsetketten sorgfältig und vollständig zu lesen.

**ATTENTION!** Pour votre sécurité, il est important que vous lisiez intégralement le manuel du propriétaire ainsi que tous les points d'avertissements.

**ENGLISH: P2-21**

**FRANCAIS: P22-41**

**DEUTSCH: P42-61**

**ESPAÑOL: P62-81**

**ITALIANO: P82-101**

## **IMPORTANT PLEASE READ THIS ENTIRE MANUAL BEFORE YOU USE YOUR AFX HELMET**

Thank you for purchasing an AFX helmet. Your AFX helmet was designed for years of comfortable use. If you follow the advice here you should be able to get the most enjoyment out of you new helmet.

Before using your new helmet, please take a moment to read the following instructions for its use and care. Failure to read and understand the contents of this owner's manual and its associated warnings could result in the helmet not protecting you in case of an accident.

## **WEARING YOUR AFX HELMET**

While no helmet can protect the user against all possible forms of impact, the following safety instructions will help you get the maximum benefit and protection from your helmet.

1. To protect you as it is designed to do, your helmet must be the correct fitted size; too big or too small may not be safe. A properly fitted helmet, with the chinstrap fastened securely, will have a snug but comfortable fit. You will feel an even pressure all over your head, with no gaps. The helmet must not be so loose that it can rotate freely front or back so that it could be removed with the chinstrap fastened.
2. The chinstrap must be securely fastened at all times do not ride with the chinstrap not fastened correctly. Make sure it remains snug at all times, except when you take it off of course.
3. Do not modify your helmet in any way and never attach anything to your helmet with screws or any type of adhesive. To preserve the integrity and effectiveness of your helmet, do not alter its internal or external structure in any way.

A helmet will only protect you if you wear it. So please remember to put it on your head before you ride. If you feel wind in your hair (or what's left of your hair) you may have forgotten to put your helmet on. Please stop riding immediately and put your helmet on. Further, the helmet must fit properly and be securely fastened on your head.

## AFX HELMET CONSTRUCTION

This helmet is designed and engineered to the DOT & ECE STANDARDS, which meets or exceeds DOT FMVSS 218 (USA/CANADA), ECE 22-05 (EUROPE,) Helmet Safety Standards.

Refer to the diagram below to familiarize your self with specific names and terms used on this helmet before attempting to request replacement parts or to replace owner serviceable parts on the helmet.

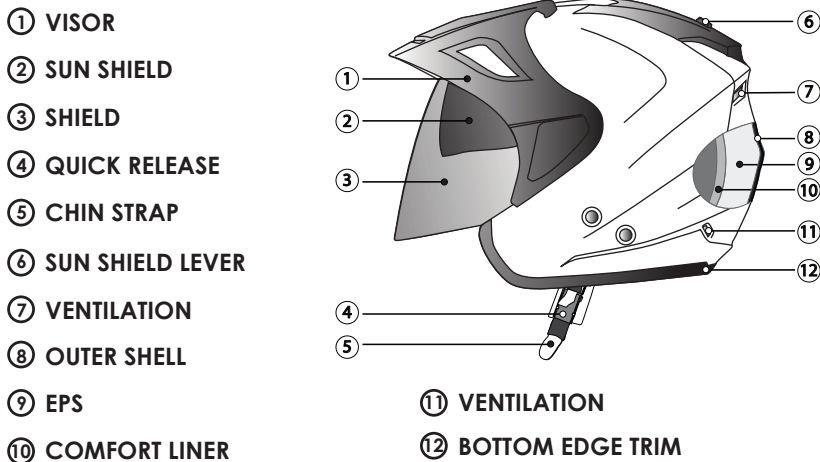

**MAKE NO MODIFICATIONS TO THE HELMET.** To maintain the full effectiveness of this helmet, there should be no alteration to any parts of the internal or external structure of this helmet or any it's associated component parts. Many types of Paints and adhesives may damage and render your helmet ineffective, without the damage being visible to the user. So don't paint and stick anything to your helmet please.

# PROPER FITTING OF YOUR AFX HELMET

## HELMETS SIZING CHART

<b>XS</b> 6 <sup>3</sup> / <sub>4</sub> - 6 <sup>7</sup> / <sub>8</sub> hat 21 <sup>1</sup> / <sub>4</sub> - 21 <sup>5</sup> / <sub>8</sub> " 54 - 55 cm	<b>S</b> 7 - 7 <sup>1</sup> / <sub>8</sub> hat 22 - 22 <sup>7</sup> / <sub>16</sub> " 56 - 57 cm	<b>M</b> 7 <sup>1</sup> / <sub>4</sub> - 7 <sup>3</sup> / <sub>8</sub> hat 22 <sup>13</sup> / <sub>16</sub> - 23 <sup>1</sup> / <sub>4</sub> " 58 - 59 cm
<b>L</b> 7 <sup>1</sup> / <sub>2</sub> - 7 <sup>5</sup> / <sub>8</sub> hat 23 <sup>5</sup> / <sub>8</sub> - 24 " 60 - 61 cm	<b>XL</b> 7 <sup>3</sup> / <sub>4</sub> - 7 <sup>7</sup> / <sub>8</sub> hat 24 <sup>3</sup> / <sub>8</sub> - 24 <sup>13</sup> / <sub>16</sub> " 62 - 63 cm	<b>XXL</b> 8 - 8 <sup>1</sup> / <sub>8</sub> hat 25 <sup>3</sup> / <sub>16</sub> - 25 <sup>5</sup> / <sub>8</sub> " 64 - 65 cm

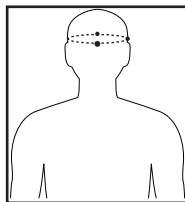

HEAD MEASUREMENT

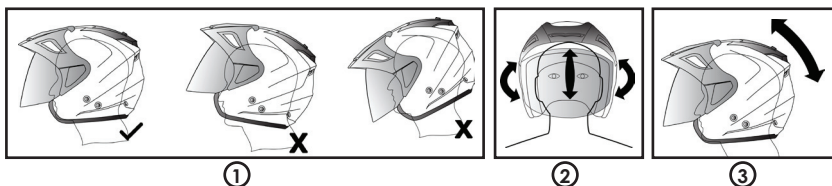

Determine the circumference of the widest part of your head by using a flexible tape measure. Generally, the widest part of a person's head is the area 2.5cm (1") above the eyes and ears. However, we suggest measuring at a few points both above and below that line to determine the greatest measurement before referring to our size tables. We also suggest testing the fit of a helmet one size smaller and one size larger than what the chart recommends. No helmet can provide protection if it's too uncomfortable to wear.

Helmets must fit snugly, but not painfully tight. While holding the chinstraps outside of the helmet, pull it down over your head, taking care that the chinstraps do not go up inside the helmet. A proper-fitting helmet will feel snug with fairly even pressure around the sides and top of your head. On most modern helmets the liner is designed to be a little extra snug at first, but will break-in after several hours of riding to match the particular shape of your head.

If you are not familiar with how a helmet should fit and feel, be sure to ask for assistance from a more experienced rider, or the retail store where you purchased your helmet. As a rule, the helmet should not be able to move around on your head without pulling on your skin. A loose fitting helmet is not only dangerous, but may also be noisy and tiring to wear. Most people make the mistake of buying a helmet that's too large. **IMPORTANT:** Make sure that you fasten the chinstrap securely beneath your chin when trying-on a helmet and then test to see that the helmet cannot be removed from your head when fastened in that manner. The helmet must not be so loose that it can rotate freely front or back so that it could be removed with the chinstrap fastened

No helmet can protect the wearer against all possible or foreseeable impacts. A helmet can only protect the portion of the head that is covered by the helmet. For maximum protection, the helmet must be well fitted with the chinstrap securely fastened. Failure to follow these instructions, the instructions printed on the helmet, and those contained in the owner's manual may result in the possibility of the helmet coming off during an accident - possibly resulting in a severe head injury or even death. While riding motorcycles, scooters, ATVs and snowmobiles is fun, it can also be a dangerous pastime. At AFX, we encourage you to enjoy riding responsibly, and to always ride within the limits of your abilities.

# CHIN STRAP RETENTION SYSTEM: QUICK RELEASE

**IMPORTANT:** Make sure that you always fasten the chinstrap securely beneath your chin when wearing your helmet. Before you ride test to see that the helmet cannot be removed from your head when fastened in that manner.

The helmet must not be worn or fastened so loose that it can rotate freely front or back so that it could be removed from your head with the chinstrap correctly fastened.

The quick release retention system featured on this helmet offers the rider the benefits of being easy to do up and remove while wearing bulky gloves; as well it offers a range of easy adjustability because of the ratcheting nature of the system. Before you ride test to see that the helmet cannot be removed from your head when the quick release retention system is adjusted for your specific fit.

To securely fasten the quick release retention systems for the first time please follow these very important set up safety instructions. Please take appropriate time to initialize this procedure, when completed and set up correctly it will provide a convenient and comfortable way to secure your helmet. It may take several attempts to get just the right fit based on your requirement, but when correctly set up the quick release retention system provides for a quick and convenient way to make sure you have the helmet secured safely and correctly.

Put the helmet on and insert the ratchet tab into the ratchet receiver. We recommend inserting the tab more than half way (5 clicks) into the receiver to initially set up your specific fit. If you don't have enough length on the strap please follow the illustrations to see how to lengthen the strap. Alternately if you have too much length on the strap following the illustrations in these directions can shorten it.

Under no circumstances should you cut the strap to make it shorter. When correctly adjusted the quick release ratchet tab should be more than half way (5 clicks) inserted into the ratchet receiver when you wear the helmet. Any excess length of strap can be threaded back through the strap buckle and the strap buckle can be positioned anywhere on the ratchet tab side of the strap to allow for extra length of strap to be secured.

Under no circumstances should the strap buckle be removed from this system. When adjusting the strap through the strap buckle make sure you always rethread it through correctly so the loose end is on the outside and is threaded through as the illustration shows. The function of the strap buckle is to stop the strap from unthreading from the ratchet tab. Failure to incorrectly use the strap buckle as illustrated could result in the failure of the retention system and the helmets ability to protect you in an accident.

Please refer to the diagrams to make sure you have done up the strap correctly, and as always do not ride with the chinstrap and retention system not done up in the correct illustrated manner. And as a reminder make sure before you ride, test to see that the helmet cannot be removed from your head when the quick release retention system is adjusted for your specific fit.

To remove the chinstrap, lift the pull-tab on the ratchet receiver as shown in the diagram below. Then you can pull out the ratchet tab. Always make sure to inspect your chinstrap and retention system either before or after every ride, if your chinstrap or retention system shows any signs of wear the helmet should be replaced immediately. Never ride with a helmet that has worn, damaged, or missing chinstrap or retention system parts. Make no modification to the chinstrap or retention system in anyway.

#### FASTEN CHIN STRAP

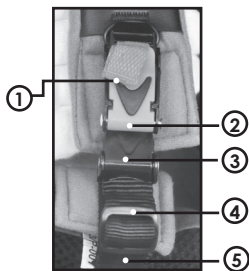
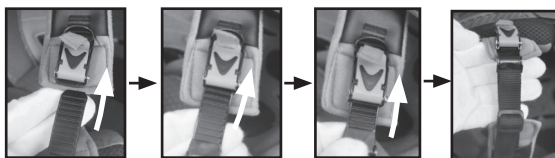

#### REMOVE CHIN STRAP

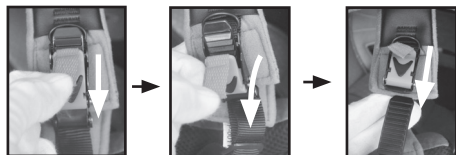

- ① PULL TAB
- ② RATCHET RECEIVER
- ③ RATCHET TAB
- ④ STRAP BUCKLE
- ⑤ CHIN STRAP

Please make sure that the chinstrap and retention system is always fastened as instructed above. Failure to do so may result in fatal injury or possible death.

# INTERIOR: CHEEK PADS & COMFORT LINER

AFX helmet liners and cheek pads are made with a hypoallergenic and anti-microbial nylon, most of which are removable and washable.

The size of this helmet is based on a combination of four factors: outer shell size, inner EPS thickness, comfort liner thickness, and cheek pad thickness. The fit of the helmet can be customized by replacing your existing cheek pads with thinner cheek pads (for a looser fit), or thicker cheek pads (for a tighter fit). The fit can also be customized by replacing your existing comfort liner with a thinner comfort liner (for a looser fit), or thicker comfort liner (for a tighter fit).

Please refer to the shell, liner and cheek pad compatibility chart below, keep in mind these components can only be replaced inside the group of sizes contained in each size range block.

And if you choose to take advantage of the ability to custom fit your helmet please keep in mind the instructions container earlier in the proper fitting guide.

HELMET SHELL & EPS SIZE	XS	S	M	L	XL	XXL
CHEEK PAD THICKNESS (MM)	48	44	40	36	32	28
COMFORT LINER THICKNESS (MM)	12	10	12	8	8	4



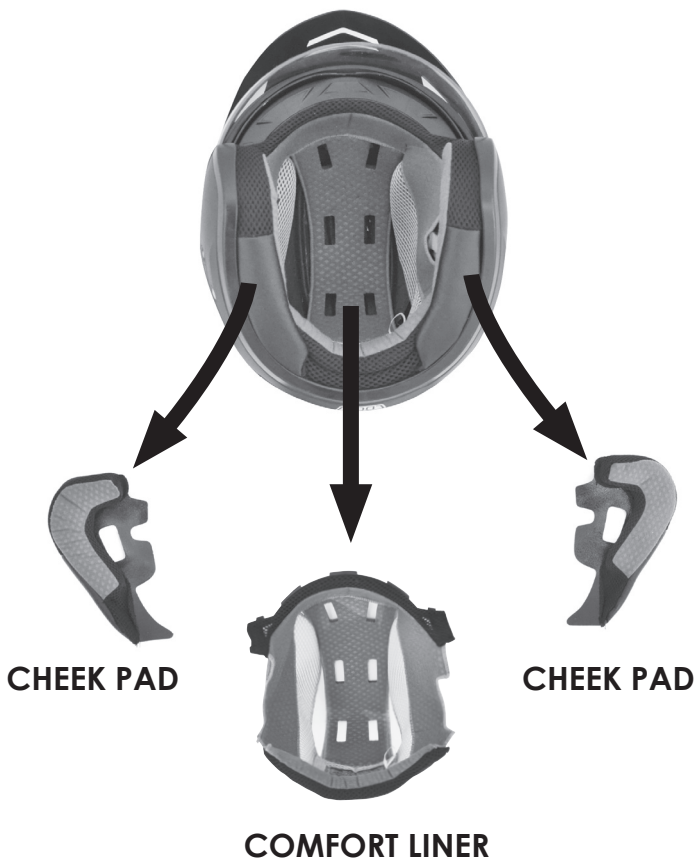

# COMFORT LINER REMOVAL

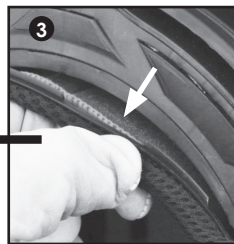
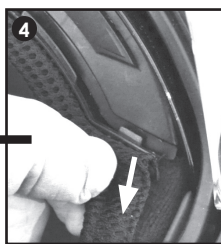
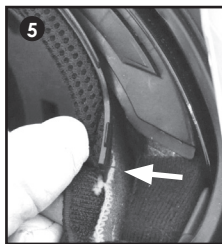
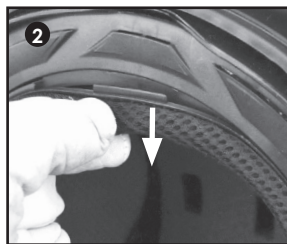
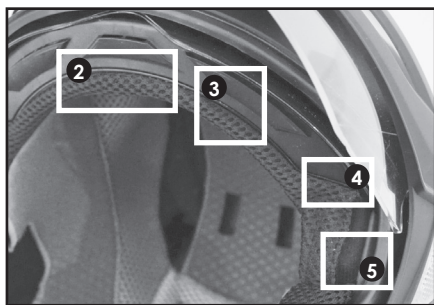
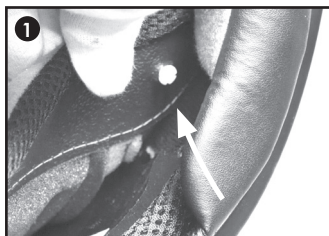
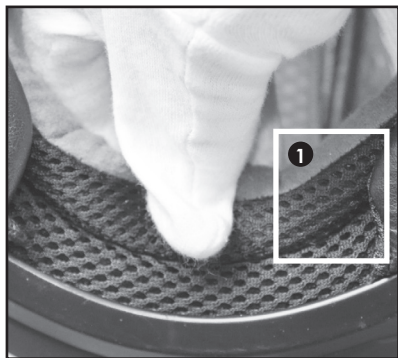

To reinstall the comfort liner, reverse steps 1 - 5.

# CHEEK PAD REMOVAL

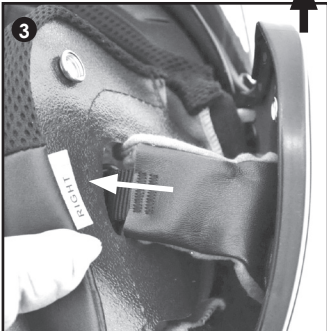
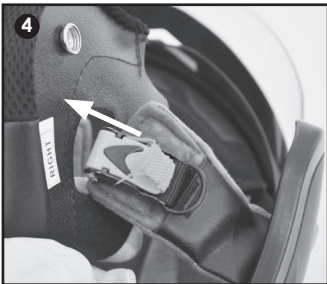
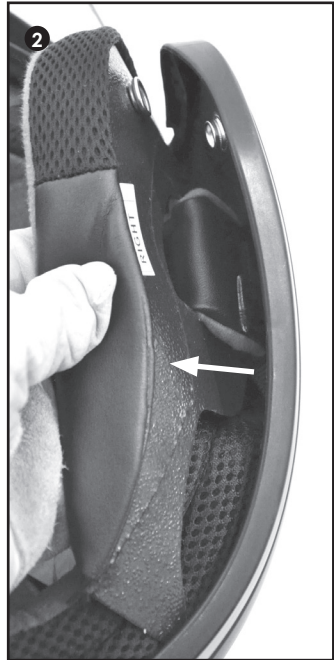
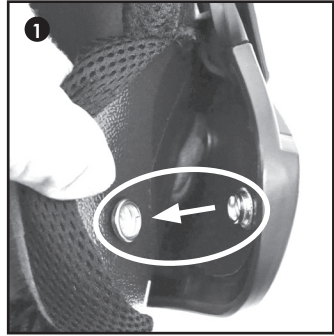

To reinstall the cheek pad, reverse steps 1 - 4.

# VISOR REMOVAL

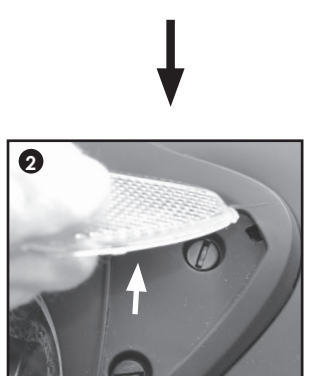
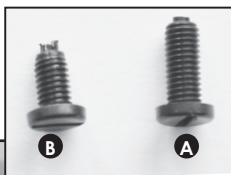
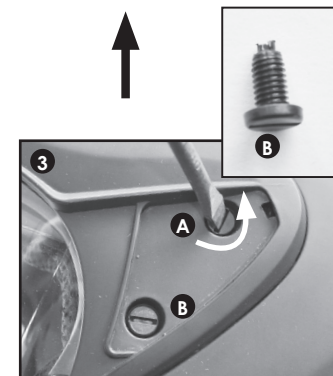
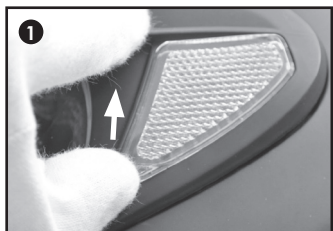

To reinstall the visor, reverse steps 1 - 4.

# SHIELD REMOVAL

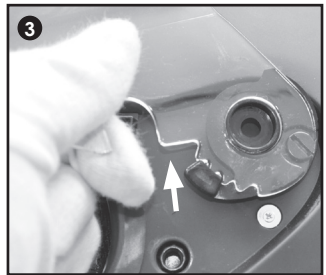
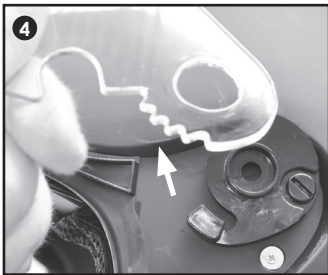
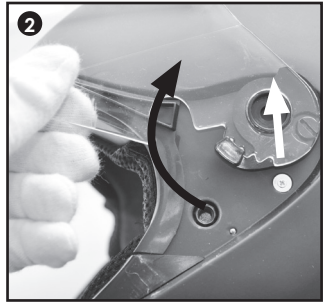
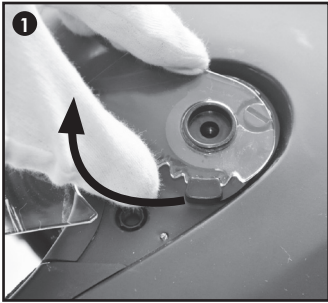
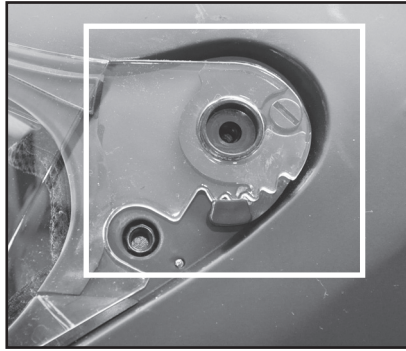

To reinstall the shield, reverse steps 1 - 4.

# SHIELD INSTALLATION

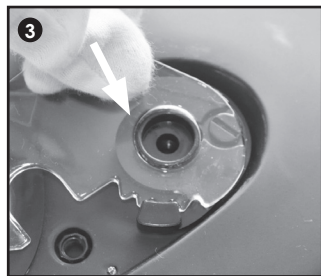
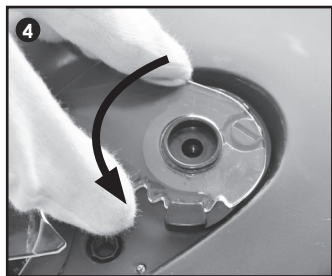
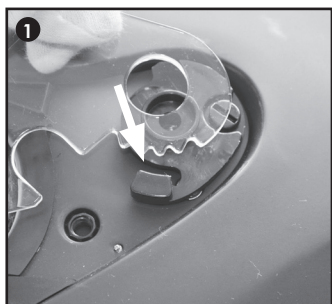
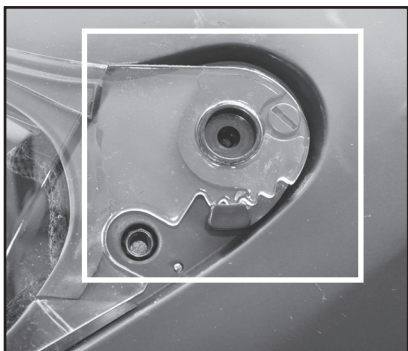

# SIDE COVER REMOVAL/INSTALLATION

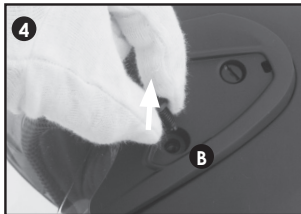
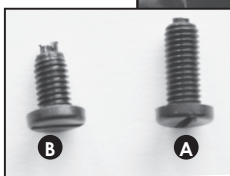
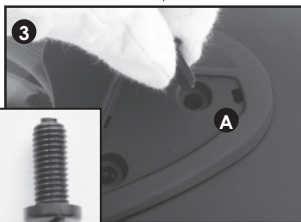
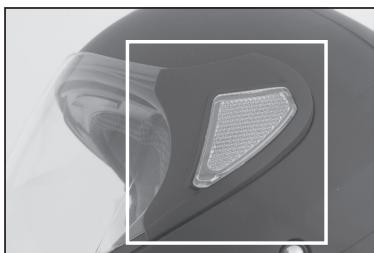

To remove the side cover, reverse steps 1 - 7.

# SUN SHIELD REMOVAL

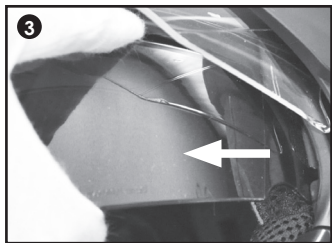
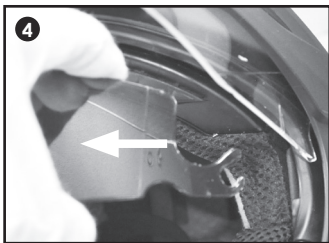
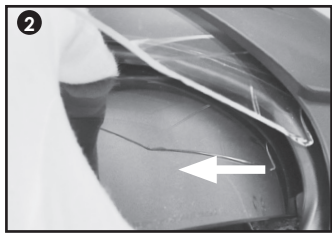
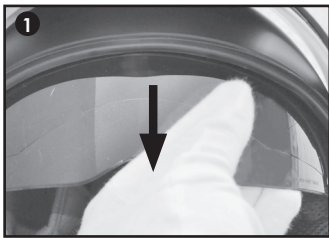
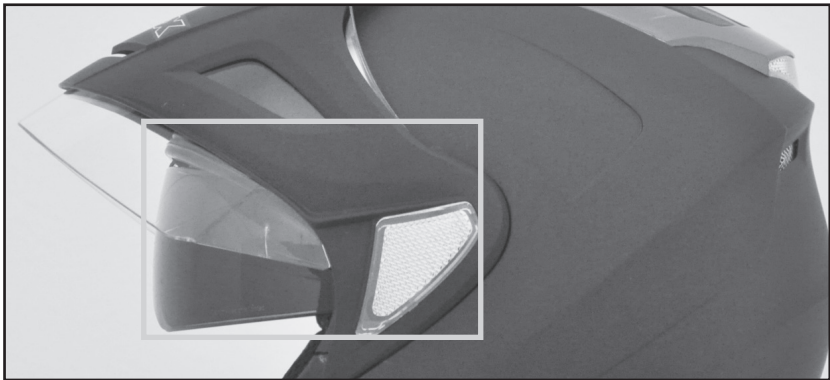



# SUN SHIELD INSTALLATION

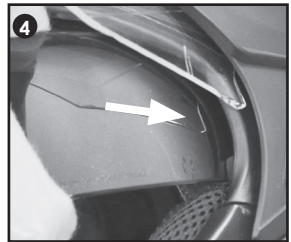
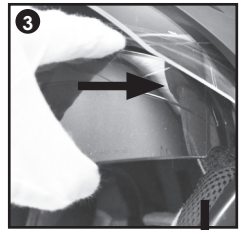
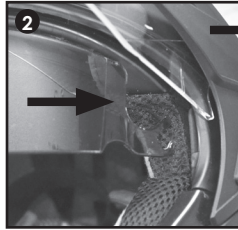
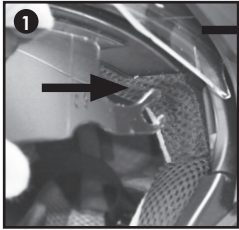
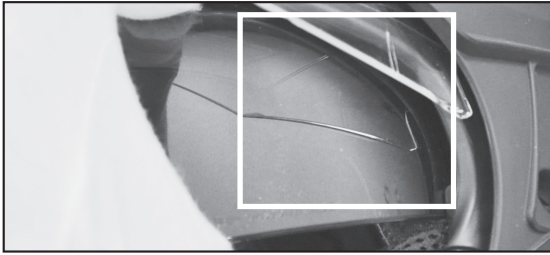

## OPEN/CLOSE THE SUN SHIELD

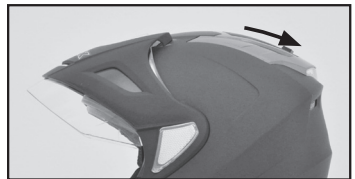
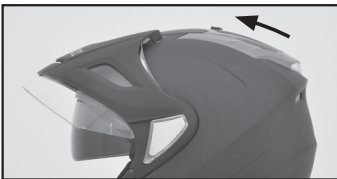

## OPEN/CLOSE THE SHIELD

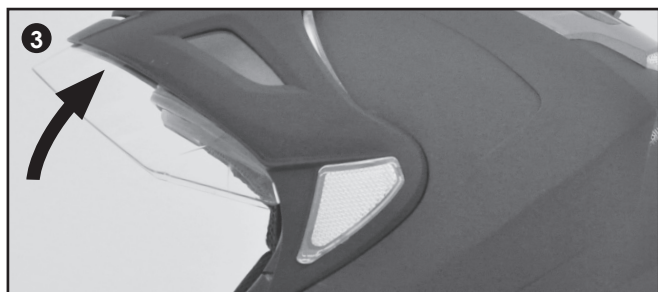
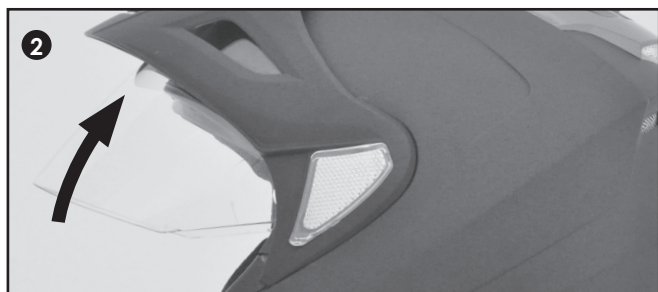
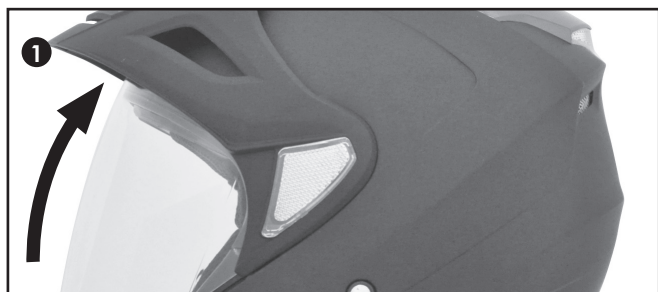

To close the shield , reverse steps 1 - 3.

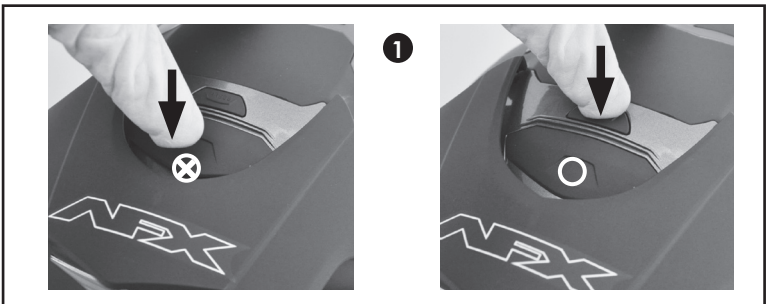
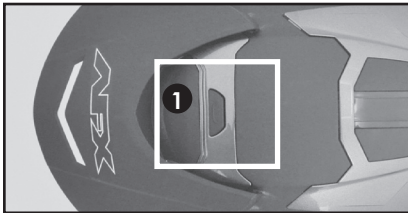

## CARE & CLEANING OF YOUR AFX HELMET

Clean your helmet liner only with mild soap and water. We recommend a mild liquid soap solution with warm but not hot water. After cleaning helmet interior, rinse with cold water and allow it to air dry at room temperature. High heat and strong cleaning solvents will damage the liner. Your helmet can be damaged without the damage being visible, by any of the following:

- Gasoline, oil, petroleum-based fluids and solvents
- Harsh or abrasive cleaning compounds
- Paints
- Adhesives

Automotive type waxes may be applied to the painted surfaces of the helmet shell to protect the finish. Only use a wax suitable for a clear-coated painted finish. If this helmet has a face shield we recommend that you use only mild soap and warm water, and dry with a soft cloth. Never use paper towels or tissues to wipe the face shields. And never use any kind of commercial glass cleaner. You may however use certain glass cleaners if they are approved for plastic surfaces. Please read all warning labels on any protectant or cleaner before using anywhere on your helmet.

## STORAGE OF YOUR AFX HELMET

Keep your helmet in a secure place when you're not using it. We recommend storing the helmet in the protective bag that was provided with your helmet; alternately we make a secure vented storage carry bag available as an option. Please see [afxhelmets.com](http://afxhelmets.com) for more information

Helmets are tough, but to maintain appearance and integrity, your helmet should be protected if it is to be stored for a long time. However we don't recommend storing your helmet for a long time because it's more fun to be riding than not riding. Any attempt to install or replace a visor or shield should be done at room temperature, as these items may be susceptible to crack in the very cold.

Be aware that pets are attracted by the accumulated salt from perspiration and may be tempted to chew on the helmet liner and cheek pads. This really does happen, so feed your pet's food, not helmets.

# **IMPORTANT SAFETY WARNING**

We at AFX recommend that any helmet suffering any kind of impact to the shell be removed from use immediately, whether there is visible physical damage or not. A helmet is designed to deform in an accident in order to absorb the energy of the impact, and should never be reused afterwards for its ability to protect the rider further could be compromised. Even a helmet dropped accidentally on the ground or any other hard surface could result in hidden unseen damage not visible to the rider.

If you suspect the integrity of the helmet has been compromised in any way please immediately discontinue its use and seek a suitable replacement. If you are not sure what to do please contact AFX through our website. [Afxhelmets.com](http://Afxhelmets.com)

Also its important to realize that wearing a helmet does not make you indestructible, so we encourage you to enjoy riding responsibly, and to always ride within the limits of your abilities.

## **HELMET REPLACEMENT RECOMMENDATION**

The expected lifespan of an AFX helmet is 4-5 years of seasonal use, and decreases accordingly as the frequency of use increases. As you would expect, helmets used for competition such, as road racing and off-road tend to have a much shorter life span. The more exposure a helmet endures to the elements, body oils, and perspiration, the faster it will wear out. In most cases the helmet liner will be the first component to wear out and, as such, functions as a good indicator that a helmet should be replaced. If you are not sure if your helmet should be replaced please contact AFX through our website. [Afxhelmets.com](http://Afxhelmets.com)

Thank you for purchasing an AFX helmet and taking the time to read this owners manual. Copies of this manual and other valuable information may be downloaded from our website, [afxhelmets.com](http://afxhelmets.com)

## **IMPORTANT : VEUILLEZ LIRE INTÉGRALEMENT CE MODE D'EMPLOI AVANT D'UTILISER VOTRE CASQUE AFX**

Merci d'avoir acheté un casque AFX. Votre casque AFX a été conçu pour une utilisation confortable et durable. Si vous suivez bien les conseils indiqués ici, vous pourrez profiter au maximum de votre nouveau casque.

Avant de vous en servir, veuillez prendre le temps de lire les instructions suivantes, pour savoir comment l'utiliser et en prendre soin. Il est très important de lire et de comprendre le contenu de ce manuel et les mises en garde qui y figurent. Si vous ne le faites pas, vous risquez de ne pas être protégé par le casque en cas d'accident.

## **PORT DU CASQUE AFX**

Même si aucun casque ne peut protéger l'utilisateur contre toutes les formes d'impact possibles, les consignes de sécurité ci-après vous aideront à tirer le meilleur parti de votre casque pour bénéficier d'une protection optimale.

1. Afin d'assurer la protection pour laquelle il est conçu, le casque doit être à la bonne taille. Pour être efficace, il ne doit être ni trop grand ni trop petit. Correctement ajusté, avec la jugulaire bien serrée, le casque sera à la fois sûr et confortable. Vous devez ressentir une pression uniforme sur toute la tête, sans espaces. Il ne faut pas que le casque soit lâche au point de pouvoir pivoter librement vers l'avant ou vers l'arrière et d'être retiré avec la jugulaire attachée.

2. La jugulaire doit toujours être solidement attachée. Ne roulez jamais sans avoir correctement fixé la jugulaire au préalable. Veillez à ce qu'elle soit toujours bien ajustée, sauf pour retirer le casque.

3. Ne modifiez en aucun cas votre casque et n'y attachez jamais quoi que ce soit à l'aide d'une vis ou d'un adhésif quelconque. Pour préserver l'intégrité et l'efficacité de votre casque, ne modifiez en aucun cas sa structure interne ou externe.

Un casque ne vous protège que si vous le portez. Alors n'oubliez pas de le mettre sur votre tête avant de partir. Vous sentez le vent dans vos cheveux (ou ce qu'il en reste) ? Vous n'auriez pas oublié de mettre votre casque par hasard ? Arrêtez-vous immédiatement et mettez votre casque. Et ce, de façon adéquate, en l'attachant convenablement.

## ÉLABORATION DU CASQUE AFX

Ce casque a été conçu et fabriqué conformément aux normes DOT et ECE, répondant ou dépassant les normes de sécurité relatives aux casques DOT FMVSS 218 (ÉTATS-UNIS/CANADA) et ECE 22-05 (EUROPE).

Reportez-vous au schéma ci-dessous afin de vous familiariser avec la terminologie utilisée sur ce casque avant de demander des pièces de rechange ou de remplacer des éléments du casque.

① VISIÈRE

② ECRAN SOLAIRE

③ ECRAN

④ RETRAIT RAPIDE

⑤ JUGULAIRE

⑥ LEVIER DE L'ECRAN SOLAIRE

⑦ VENTILATION

⑧ COQUE EXTERNE

⑨ DOUBLURE D'ABSORPTION D'IMPACT

⑩ DOUBLURE CONFORT

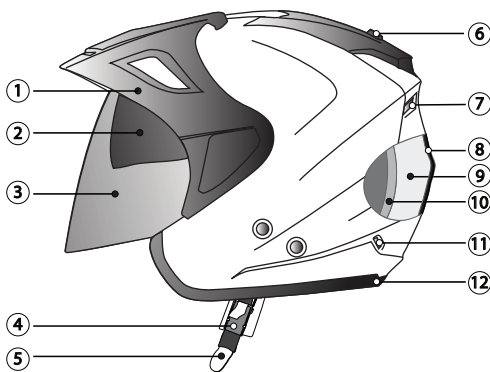

⑪ VENTILATION

⑫ GARNITURE BASSE

N'EFFECTUEZ AUCUNE MODIFICATION SUR LE CASQUE. Afin de garantir l'efficacité optimale de ce casque, ne modifiez aucun élément de sa structure interne ou externe, ni aucun des composants associés. De nombreux types de peintures et d'adhésifs sont susceptibles d'endommager votre casque, voire de le rendre impropre à l'usage (sans que cela soit détectable à l'œil nu). Il ne faut donc pas peindre ou coller quoi que ce soit sur votre casque.

# AJUSTAGE ADÉQUAT DU CASQUE AFX

## TABLEAU DE CONVERSATION TAILLE

<b>XS</b> 6 <sup>3</sup> / <sub>4</sub> - 6 <sup>7</sup> / <sub>8</sub> hat 21 <sup>1</sup> / <sub>4</sub> - 21 <sup>5</sup> / <sub>8</sub> '' 54 - 55 cm	<b>S</b> 7 - 7 <sup>1</sup> / <sub>8</sub> hat 22 - 22 <sup>7</sup> / <sub>16</sub> '' 56 - 57 cm	<b>M</b> 7 <sup>1</sup> / <sub>4</sub> - 7 <sup>3</sup> / <sub>8</sub> hat 22 <sup>13</sup> / <sub>16</sub> - 23 <sup>1</sup> / <sub>4</sub> '' 58 - 59 cm
<b>L</b> 7 <sup>1</sup> / <sub>2</sub> - 7 <sup>5</sup> / <sub>8</sub> hat 23 <sup>5</sup> / <sub>8</sub> - 24 '' 60 - 61 cm	<b>XL</b> 7 <sup>3</sup> / <sub>4</sub> - 7 <sup>7</sup> / <sub>8</sub> hat 24 <sup>3</sup> / <sub>8</sub> - 24 <sup>13</sup> / <sub>16</sub> '' 62 - 63 cm	<b>XXL</b> 8 - 8 <sup>1</sup> / <sub>8</sub> hat 25 <sup>3</sup> / <sub>16</sub> - 25 <sup>5</sup> / <sub>8</sub> '' 64 - 65 cm

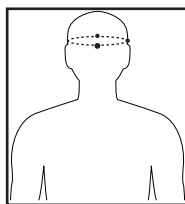

TOUR DE TÊTE

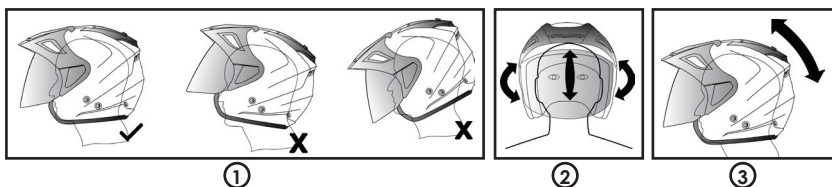

Déterminez la circonférence de la partie la plus large de votre crâne, à l'aide d'un mètre ruban. En général, la partie la plus large du crâne humain correspond à la zone située à 2,5 cm au-dessus des yeux et des oreilles. Nous vous conseillons toutefois d'effectuer des mesures en différents points, au-dessus et en dessous de cette ligne, afin de déterminer la meilleure mesure avant de vous référer à nos tableaux de tailles. Nous vous conseillons également d'essayer un casque une taille en dessous et une taille au-dessus de celle recommandée par le tableau. Aucun casque ne peut assurer de protection s'il est trop désagréable à porter.

Les casques doivent s'ajuster parfaitement, mais sans faire mal. Tout en maintenant les jugulaires à l'extérieur du casque, mettez-le sur votre tête, en faisant attention à ne pas coincer les jugulaires à l'intérieur du casque. Un casque bien ajusté procure une sensation de confort, avec une pression relativement uniforme sur les côtés et le haut de la tête. Sur la plupart des casques modernes, la doublure est conçue pour serrer un peu plus au début, puis se détendre au bout de quelques heures d'utilisation, pour s'adapter à la forme particulière de votre tête.



Si vous n'avez pas l'habitude des casques et ne savez pas bien comment ils doivent s'ajuster, demandez conseil à une personne plus expérimentée ou au magasin où vous avez acheté votre casque. De manière générale, il ne doit pas être possible de faire bouger le casque sur votre tête sans tirer sur la peau. Un casque mal ajusté est non seulement dangereux, il peut aussi s'avérer bruyant et fatiguant à porter. La plupart des gens commettent l'erreur d'acheter un casque trop grand. **IMPORTANT** : veillez à bien serrer la jugulaire sous le menton lorsque vous essayez un casque et vérifiez ensuite qu'il n'est pas possible de l'enlever de la tête lorsqu'il est ainsi attaché. Il ne faut pas que le casque soit lâche au point de pouvoir pivoter librement vers l'avant ou vers l'arrière et d'être retiré avec la jugulaire attachée.

Aucun casque ne peut protéger complètement son utilisateur contre un éventuel impact. Le casque ne peut protéger que la partie de la tête qu'il recouvre. Pour assurer une protection optimale, le casque doit être parfaitement ajusté avec la jugulaire bien attachée. Si vous ne respectez pas ces instructions, les instructions imprimées sur le casque et celles figurant dans le mode d'emploi, il existe un risque d'éjection du casque en cas d'accident, susceptible d'entraîner des blessures graves à la tête, voire la mort. La moto, le scooter, le VTT ou la motoneige sont des passe-temps agréables, qui comportent aussi leur part de risque. AFX vous invite à profiter de votre engin de manière responsable et à toujours conduire dans les limites de vos capacités.

**IMPORTANT** : veillez à toujours bien attacher la jugulaire sous le menton lorsque vous portez le casque. Avant de partir, vérifiez qu'il n'est pas possible de retirer le casque de la tête lorsqu'il est attaché de cette manière.

Il ne faut pas que le casque soit porté ou attaché de manière lâche au point de pouvoir pivoter librement vers l'avant ou vers l'arrière et d'être retiré de la tête avec la jugulaire correctement attachée.

Le système de fixation à retrait rapide dont ce casque est pourvu présente plusieurs avantages : il est facile à mettre et à retirer malgré le port de gants encombrants ; il offre également toute une série de réglages faciles, grâce au fonctionnement à cliquet du système. Avant de partir, vérifiez qu'il n'est pas possible de retirer le casque de votre tête lorsque le système de fixation à retrait rapide est ajusté spécialement à votre taille.

Pour attacher solidement le système de fixation à retrait rapide pour la première fois, veuillez observer ces consignes de sécurité très importantes. Veuillez consacrer le temps nécessaire à cette procédure. Une fois terminée et correctement définie, elle permettra de fixer votre casque de manière appropriée et confortable. Vous devrez peut-être vous y prendre à plusieurs fois pour obtenir un ajustage parfait en fonction de vos besoins. Mais une fois correctement configuré, le système de fixation à retrait rapide s'avère très pratique pour être sûr que le casque est correctement attaché, pour une sécurité optimale.

Mettez le casque sur la tête et insérez la languette du cliquet dans le récepteur à cliquet. Nous vous conseillons d'insérer la languette à plus de la moitié (5 clics) dans son récepteur pour le réglage initial de votre ajustage spécifique. Si vous n'avez pas assez de longueur sur la bride, veuillez consulter les illustrations pour savoir comment la rallonger. Si vous avez trop de longueur sur la bride, vous pouvez la raccourcir en suivant les illustrations.

Il ne faut jamais couper la bride pour la raccourcir. Lorsqu'elle est correctement ajustée, la languette du cliquet à retrait rapide doit être insérée à plus de la moitié (5 clics) dans son récepteur lorsque vous portez le casque. Si la bride est trop longue, vous pouvez la refaire passer dans sa boucle et placer celle-ci sur le côté de la languette du cliquet de la bride, afin de fixer la partie qui dépasse.

Il ne faut jamais retirer la boucle de la bride de ce système. Lorsque vous ajustez la bride à travers la boucle, veillez à toujours l'enfiler de nouveau correctement de manière à ce que l'extrémité libre se trouve à l'extérieur et soit enfilée comme indiqué sur l'illustration. La boucle de la bride a pour but d'éviter que la bride ne sorte de la languette. Si vous n'utilisez pas correctement la boucle de la bride comme illustré, cela risque de compromettre le fonctionnement du système de fixation et la capacité de protection du casque en cas d'accident.

Veillez vous reporter aux schémas pour vérifier que vous avez fixé correctement la bride. Comme toujours, ne roulez pas sans avoir fixé correctement la jugulaire et le système de fixation au préalable, comme sur l'illustration. N'oubliez pas non plus de vérifier, avant de partir, qu'il n'est pas possible de retirer le casque de votre tête lorsque le système de fixation à retrait rapide est ajusté spécialement pour vous.

Pour retirer la jugulaire, soulevez la languette sur le récepteur à cliquet comme indiqué sur le schéma ci-dessous. Vous pouvez ensuite retirer la languette du cliquet. N'oubliez pas d'inspecter systématiquement la jugulaire et le système de fixation, avant ou après chaque utilisation. Si l'un ou l'autre montre des signes d'usure quelconques, il convient de remplacer immédiatement le casque. Ne roulez jamais avec un casque usé ou abîmé, ou s'il manque des pièces aux jugulaires ou au système de fixation. Vous ne devez jamais modifier la jugulaire ou le système de fixation d'une quelconque manière.

#### BOUCLE A FERMETURE RAPIDE

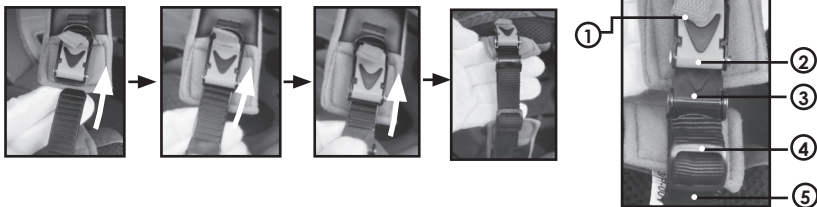

#### BOUCLE A OUVERTURE RAPIDE

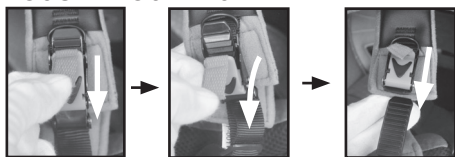

- ① TIREZ LA LANGUETTE
- ② LA RÉCEPTEUR A CLIQUET
- ③ LA LANGUETTE DU CLIQUET
- ④ BOUCLE DE JUGULAIRE
- ⑤ JUGULAIRE

Veillez à bien attacher la jugulaire et le système de fixation en respectant les consignes ci-dessus. Leur non-respect peut entraîner des blessures graves, voire mortelles.

## INTÉRIEUR : MOUSSES DE JOUE ET DOUBLURE DE CONFORT

Les doublures et mousses de joue du casque AFX sont en nylon hypoallergénique et anti-microbien. La plupart sont amovibles et lavables.

La taille de ce casque est basée sur une combinaison de quatre facteurs : taille de la coque externe, épaisseur du PSE interne, épaisseur de la doublure de confort et épaisseur de la mousse de joue. Il est possible de personnaliser l'ajustage du casque en remplaçant les mousses de joue par des mousses plus minces (pour un ajustage plus lâche) ou plus épaisses (pour un ajustage plus serré). Vous pouvez également remplacer la doublure de confort par une doublure plus mince (pour un ajustage plus lâche) ou plus épaisse (pour un ajustage plus serré).

Veillez vous reporter au tableau de compatibilité des coques, doublures et mousses de joue ci-dessous. N'oubliez pas que le remplacement de ces composants doit s'effectuer exclusivement dans le groupe de tailles correspondant à chaque bloc de plage de taille.

En outre, si vous décidez de personnaliser l'ajustage de votre casque, n'oubliez pas les consignes indiquées précédemment dans le guide d'ajustage.

DIMENSION DU CASQUE	XS	S	M	L	XL	XXL
TAILLE DE MOUSSE DE JOUE(MM)	48	44	40	36	32	28
TAILLE DE DOUBLURE CONFORT (MM)	12	10	12	8	8	4

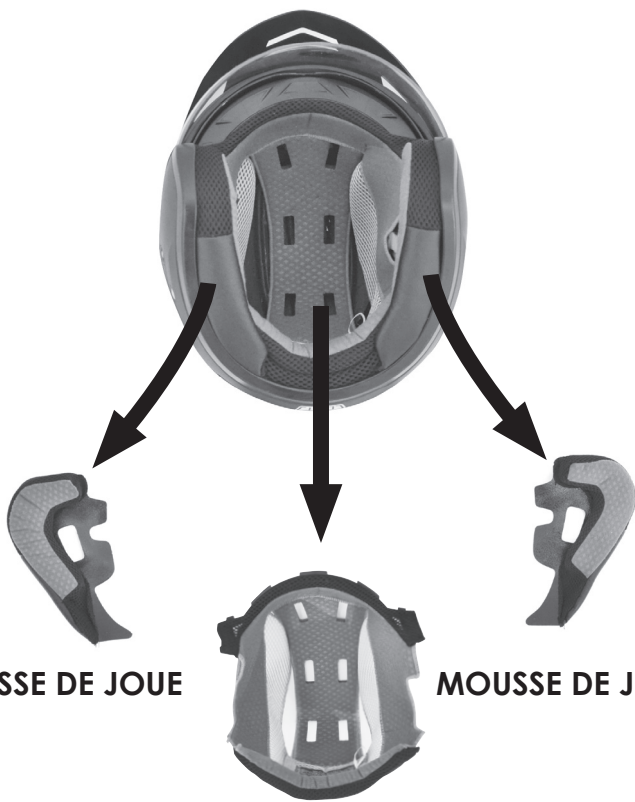

**MOUSSE DE JOUE**

**MOUSSE DE JOUE**

**DOUBLURE CONFORT**

# RETRAIT DE LA DOUBLURE DE CONFORT

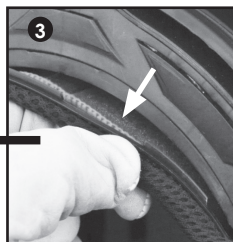
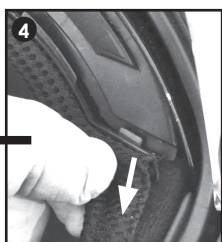
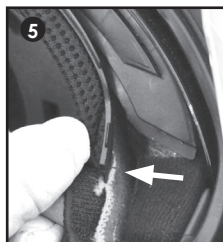
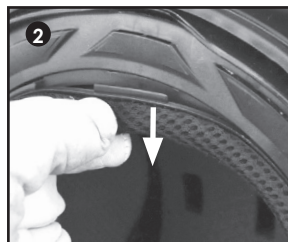
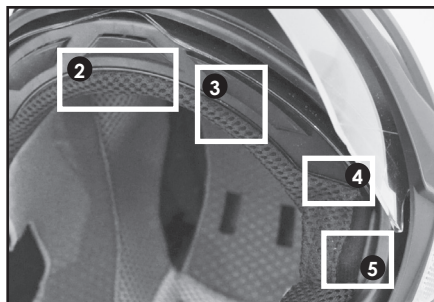
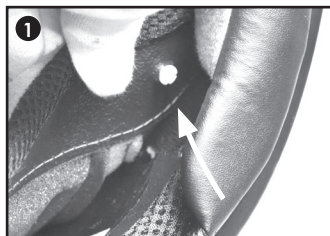
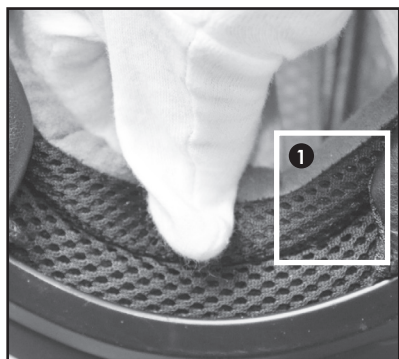

Pour remettre la doublure de confort en place, procédez en inversant les étapes 1 à 5.

# RETRAIT DES MOUSSES DE JOUE

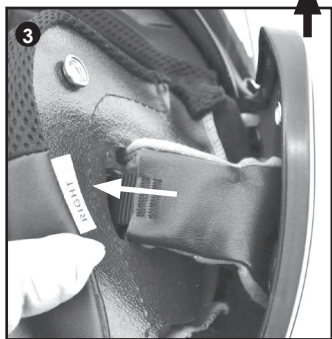
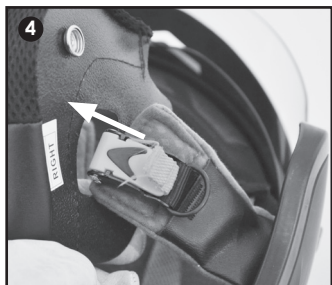
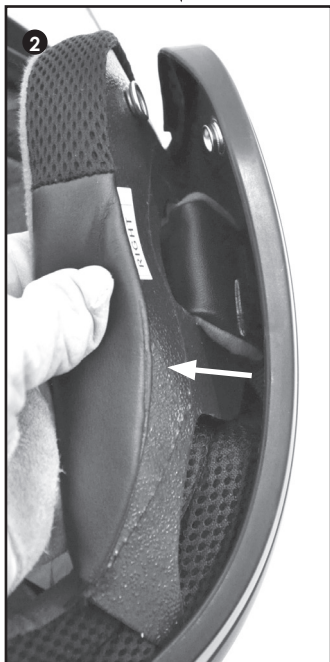
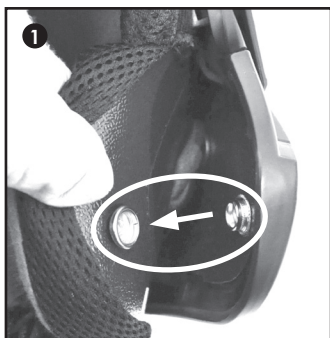
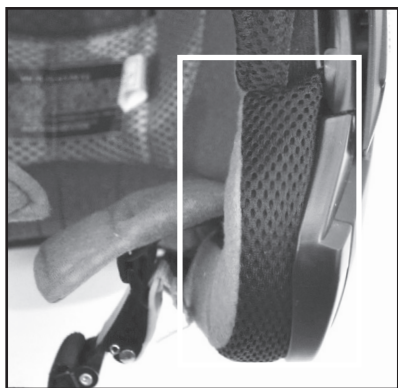

Pour remettre les mousses de joue en place, procédez en inversant les étapes 1 à 4.

# RETRAIT DE LA VISIÈRE

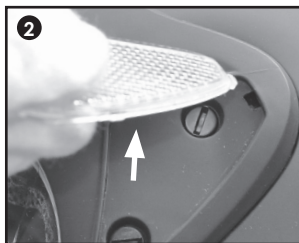
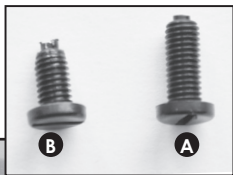
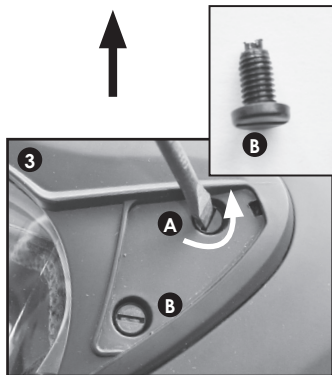
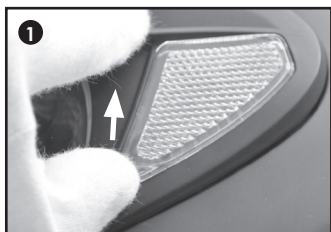
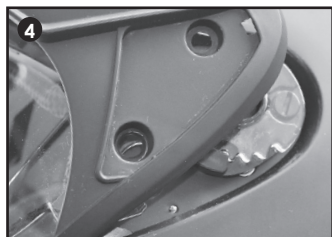
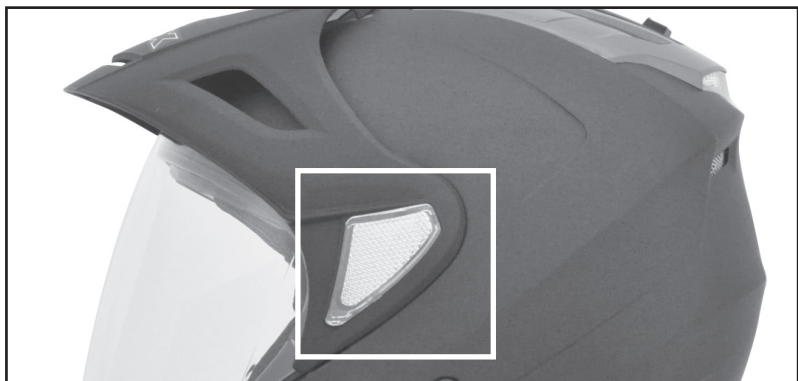

Pour remettre la visière revoir point 1 - 4



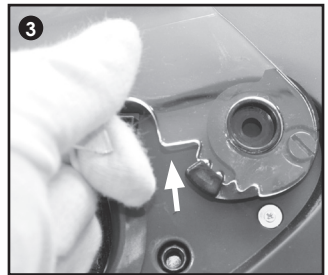
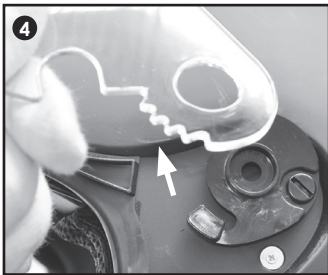
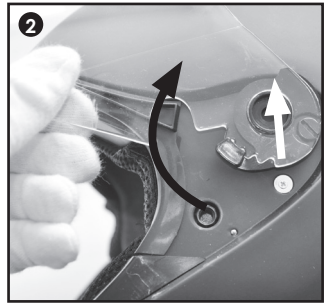
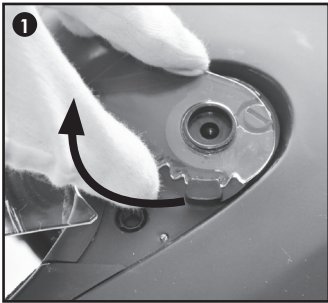
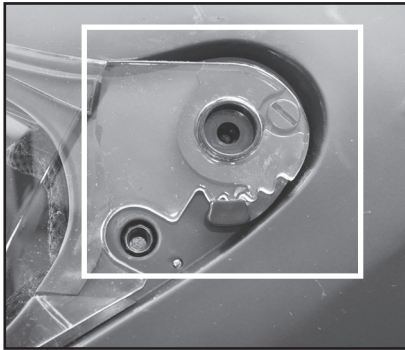

Pour remettre l'écran revoir point 1 - 4

# INSTALLATION DU VISIÈRE

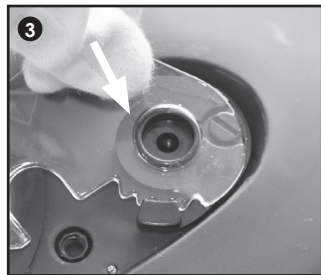
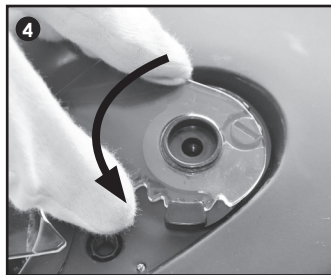
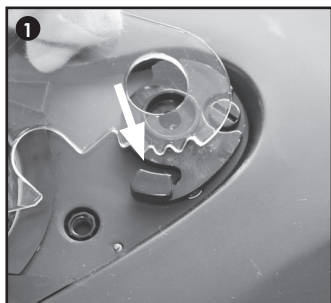
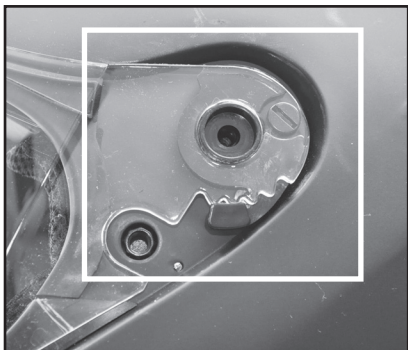

# RETRAIT/MISE EN PLACE DE LA PLATINE

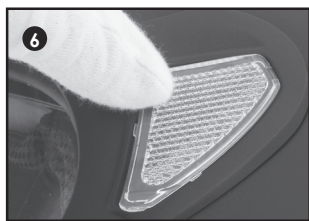
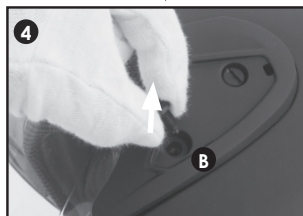
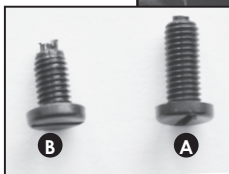
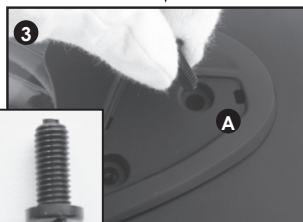

Pour enlever la platine voir point 1 - 7

# RETRAIT DE L'ECRAN SOLAIRE

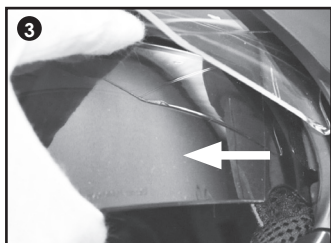
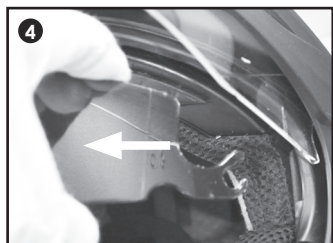
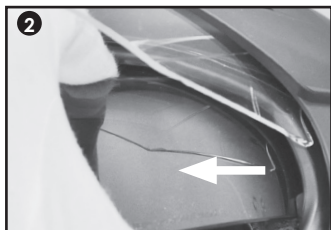
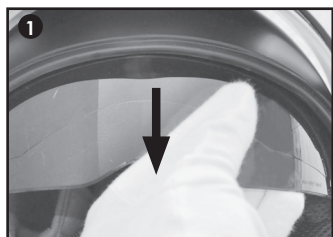
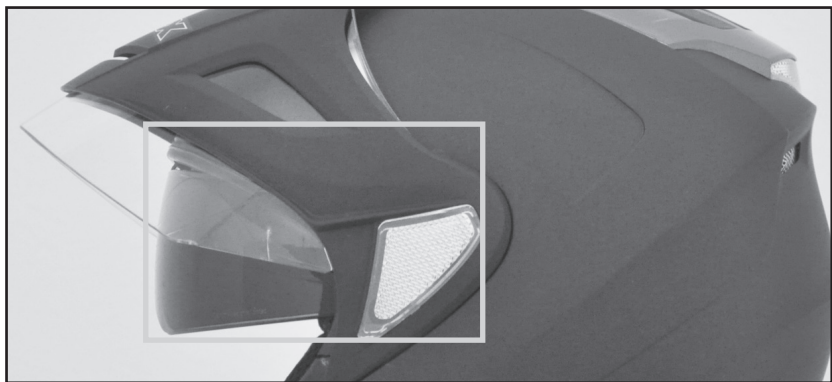

# MISE EN PLACE DE L'ECRAN SOLAIRE

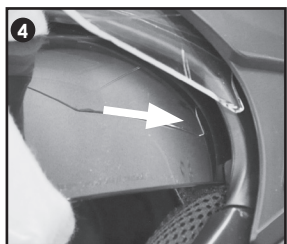
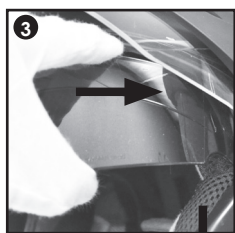
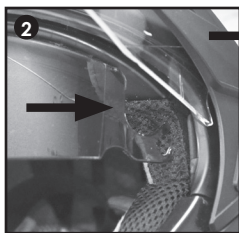
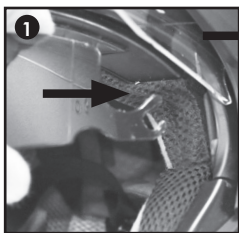
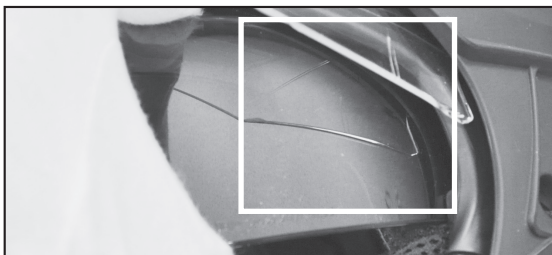

# OUVERTURE / FERMETURE DE L'ECRAN SOLAIRE

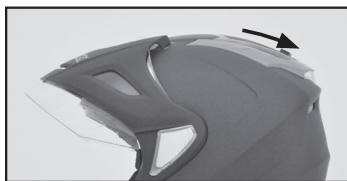
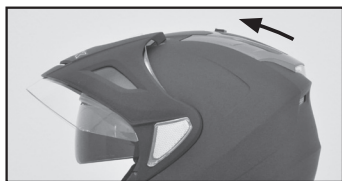

# OUVERTURE / FERMETURE DE L'ECRAN

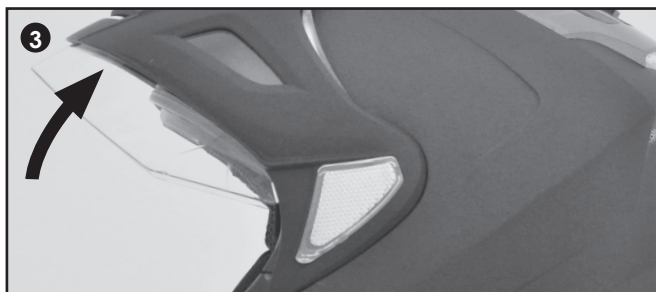
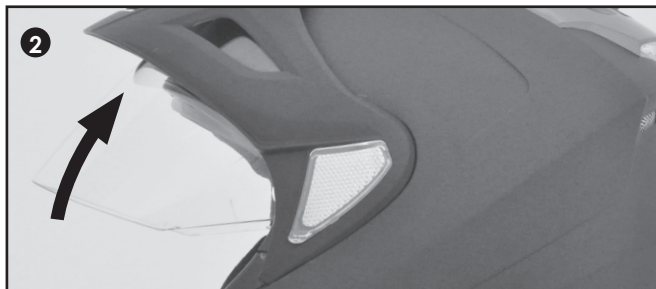
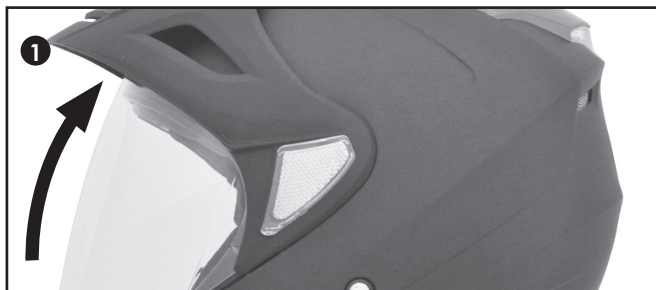

**Pour fermer l'écran voir point 1-3**

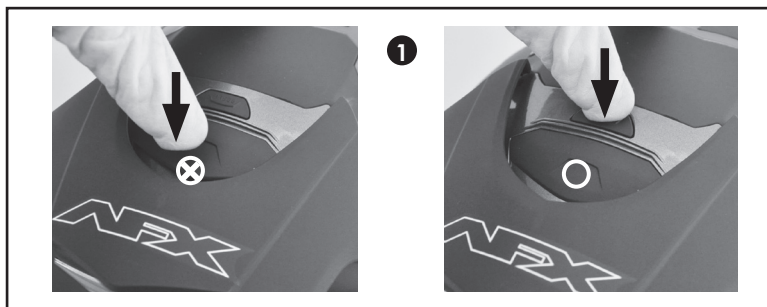
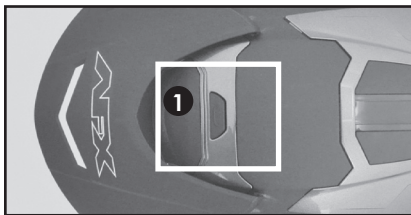

# ENTRETIEN ET NETTOYAGE DU CASQUE AFX

Nettoyez la doublure de votre casque exclusivement au savon doux et à l'eau. Nous recommandons d'utiliser un savon liquide doux avec de l'eau tiède (jamais chaude). Après avoir nettoyé l'intérieur du casque, rincez à l'eau froide et laissez sécher à l'air à température ambiante. Une forte chaleur et des produits de nettoyage puissants abîmeront la doublure. Il est possible que votre casque s'abîme sans que cela se voie, à cause de l'un des produits suivants :

- Essence, huile, liquides et solvants à base de pétrole
- Produits de nettoyage agressifs ou abrasifs
- Peintures
- Adhésifs

Il est possible d'appliquer des cires pour automobile sur les surfaces peintes de la coque du casque pour en protéger la finition. Utilisez exclusivement une cire adaptée à une finition de peinture transparente. Si ce casque est doté d'une visière, nous vous conseillons d'utiliser exclusivement du savon doux et de l'eau tiède, puis de le sécher à l'aide d'un chiffon doux. N'essuyez jamais les visières avec de l'essuie-tout ou des mouchoirs en papier. Surtout, n'utilisez jamais de produit de nettoyage pour vitres vendu dans le commerce. Il est toutefois possible d'utiliser certains produits de nettoyage pour vitres s'ils conviennent aux surfaces en plastique. Veuillez lire toutes les étiquettes d'avertissement figurant sur les produits avant de les utiliser sur votre casque.

## STOCKAGE DU CASQUE AFX

Rangez votre casque en lieu sûr lorsque vous ne l'utilisez pas. Nous vous conseillons de ranger le casque dans la housse de protection fournie avec celui-ci. Nous proposons également en option un sac de rangement ventilé et sécurisé. Pour plus d'informations, veuillez consulter le site [afxhelmets.com](http://afxhelmets.com)

Même si les casques sont résistants, pour préserver leur apparence et leur intégrité, il convient de les protéger s'ils doivent être stockés pendant une période prolongée. Bien sûr, il est préférable de ne pas de stocker votre casque pendant une période prolongée, puisqu'il est beaucoup plus agréable de pratiquer régulièrement votre sport favori. Si vous devez installer ou remplacer une visière ou un renfort, il faut le faire à température ambiante, puisque ces articles peuvent être susceptibles de se fendre en cas de froid intense.

Sachez que les animaux domestiques sont attirés par l'accumulation de sel de la sueur, ce qui peut les inciter à mordiller la doublure du casque et les mousses de joue. C'est malheureusement une chose qui arrive, alors donnez bien à manger à vos animaux et faites attention à votre casque.



# **AVERTISSEMENT DE SÉCURITÉ IMPORTANT**

Chez AFX, nous conseillons de cesser immédiatement d'utiliser un casque dont la coque a subi un impact quelconque, qu'un dommage physique soit visible ou non. Un casque est conçu pour se déformer en cas d'accident, afin d'absorber l'énergie de l'impact. Il ne faut jamais le réutiliser par la suite puisque sa fonction de protection de l'utilisateur risquerait d'être compromise. Même en cas de chute accidentelle d'un casque, par terre ou sur une autre surface dure, cela peut entraîner un dommage caché, invisible pour l'utilisateur.

Si vous pensez que l'intégrité du casque a pu être compromise d'une quelconque manière, veuillez immédiatement cesser de l'utiliser et le remplacer comme il convient. Si vous n'êtes pas sûr de ce qu'il faut faire, adressez-vous à AFX via notre site Internet. [Afxhelmets.com](http://Afxhelmets.com)

Il est aussi important d'avoir conscience que le port d'un casque ne vous rend pas indestructible. Nous vous invitons donc à profiter de votre engin de manière responsable et à toujours conduire dans les limites de vos capacités.

## **RECOMMANDATIONS RELATIVES AU REMPLACEMENT DU CASQUE**

La durée de vie prévue pour un casque AFX est de 4 à 5 ans d'utilisation saisonnière. Elle diminue en conséquence si la fréquence d'utilisation augmente. Bien sûr, les casques utilisés pour la compétition (course automobile et rallye par exemple) ont tendance à avoir une durée de vie beaucoup plus courte. Plus un casque est exposé aux éléments, au sébum et à la transpiration, plus il s'use vite. Dans la plupart des cas, la doublure du casque est le premier composant à s'user. C'est pourquoi on peut la considérer comme un bon indicateur pour savoir à quel moment un casque doit être remplacé. Si vous n'êtes pas sûr du moment où votre casque doit être remplacé, adressez-vous à AFX via notre site Internet. [Afxhelmets.com](http://Afxhelmets.com)

Merci d'avoir acheté un casque AFX et d'avoir pris le temps de lire ce mode d'emploi. Vous pouvez télécharger un exemplaire de ce mode d'emploi et d'autres informations utiles sur notre site Internet [afxhelmets.com](http://afxhelmets.com)

## **LESEN SIE BITTE UNBEDINGT DIE GESAMTE BENUTZERANLEITUNG DURCH, BEVOR SIE DEN AFX-HELM VERWENDEN**

Vielen Dank, dass Sie sich für einen Helm von AFX entschieden haben. Ihr AFX-Helm ist auf eine langjährige Verwendung ausgelegt. Wenn Sie unsere Ratschläge berücksichtigen, werden Sie viel Freude damit haben.

Nehmen Sie sich vor der Verwendung Ihres neuen Helms bitte einen Moment Zeit und lesen Sie die folgenden Pflege- und Benutzungshinweise. Das Nichtbeachten dieser Benutzeranleitung und der darin enthaltenen Warnungen kann dazu führen, dass der Helm bei einem Unfall keinen Schutz bietet.

## **TRAGEN DES AFX-HELMS**

Kein Helm kann den Träger vor jedem vorhersehbaren Aufprall schützen. Die folgenden Sicherheitshinweise zeigen Ihnen, wie Ihr Helm die größtmögliche Schutzwirkung erzielt.

1. Damit Ihr Helm optimalen Schutz bietet, müssen Sie unbedingt die passende Größe auswählen. Er darf weder zu groß noch zu klein sein. Ob der Helm passt, erkennen Sie daran, dass er bei angezogenem Kinnriemen fest, aber komfortabel sitzt. Sie sollten gleichmäßigen Druck auf dem Kopf verspüren. Wenn sich der Helm vorne oder hinten drehen oder mit festgezogenem Kinnriemen abnehmen lässt, ist er zu groß.

2. Der Kinnriemen muss beim Tragen des Helms stets fest angezogen sein. Fahren Sie niemals, ohne dass der Kinnriemen sachgemäß festgezogen ist. Stellen Sie sicher, dass der Helm während des Tragens jederzeit fest anliegt.

3. Nehmen Sie keine Änderungen am Helm vor und befestigen Sie niemals etwas mit Schrauben oder Klebstoff daran. Damit die Stabilität und das Leistungsvermögen des Helms so lange wie möglich erhalten bleiben, dürfen weder am Inneren noch am Äußeren Änderungen an der Struktur vorgenommen werden.

Ein Helm schützt nur, wenn er auch getragen wird. Vergessen Sie das nicht. Wenn Sie den Fahrtwind im Haar spüren (oder in dem, was davon noch übrig ist), haben Sie nicht an Ihren Helm gedacht. Steigen Sie sofort ab und setzen Sie ihn auf. Darüber hinaus muss der Helm sicher und fest sitzen.

## AUFBAU DES AFX-HELMS

Dieser Helm wurde gemäß den Normen DOT und ECE konzipiert, die wiederum die Helmsicherheitsnormen DOT FMVSS 218 (USA/KANADA) und ECE 22-05 (EUROPA) erfüllen bzw. diese sogar übertreffen.

Machen Sie sich anhand der folgenden Abbildung mit den Bezeichnungen dieses Helms vertraut, bevor Sie Ersatzteile anfordern oder versuchen, Teile des Helms zu ersetzen.

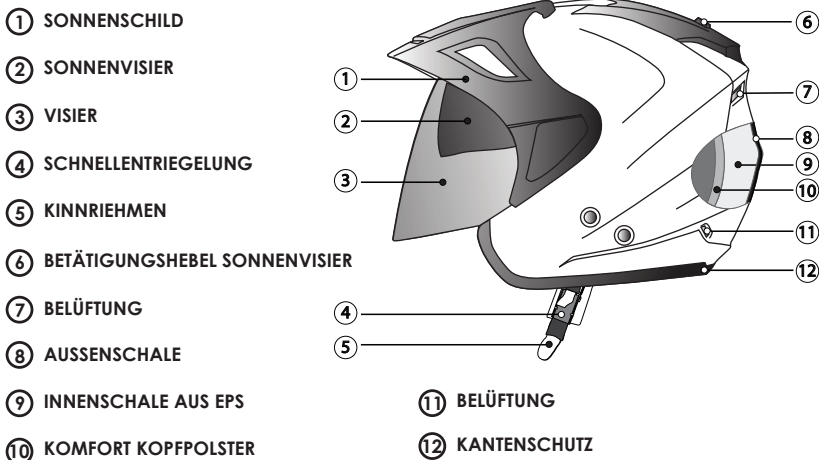

**NEHMEN SIE KEINE ÄNDERUNGEN AM HELM VOR.** Um die volle Wirksamkeit dieses Helms zu gewährleisten, dürfen an der inneren oder äußeren Struktur oder den Komponenten des Helms keinerlei Änderungen vorgenommen werden. Viele Farb- und Klebstoffe können den Helm beschädigen und seine Effektivität erheblich einschränken, auch wenn die Folgen mit bloßem Auge nicht erkennbar sind. Sie sollten Ihren Helm also weder bemalen noch mit Aufklebern verzieren.

# BESTIMMEN DER AFX-HELMGRÖSSE

## HELMGRÖSSENTABELLE

<b>XS</b> 6 <sup>3</sup> / <sub>4</sub> - 6 <sup>7</sup> / <sub>8</sub> hat 21 <sup>1</sup> / <sub>4</sub> - 21 <sup>5</sup> / <sub>8</sub> '' 54 - 55 cm	<b>S</b> 7 - 7 <sup>1</sup> / <sub>8</sub> hat 22 - 22 <sup>7</sup> / <sub>16</sub> '' 56 - 57 cm	<b>M</b> 7 <sup>1</sup> / <sub>4</sub> - 7 <sup>3</sup> / <sub>8</sub> hat 22 <sup>13</sup> / <sub>16</sub> - 23 <sup>1</sup> / <sub>4</sub> '' 58 - 59 cm
<b>L</b> 7 <sup>1</sup> / <sub>2</sub> - 7 <sup>5</sup> / <sub>8</sub> hat 23 <sup>5</sup> / <sub>8</sub> - 24 '' 60 - 61 cm	<b>XL</b> 7 <sup>3</sup> / <sub>4</sub> - 7 <sup>7</sup> / <sub>8</sub> hat 24 <sup>3</sup> / <sub>8</sub> - 24 <sup>13</sup> / <sub>16</sub> '' 62 - 63 cm	<b>XXL</b> 8 - 8 <sup>1</sup> / <sub>8</sub> hat 25 <sup>3</sup> / <sub>16</sub> - 25 <sup>5</sup> / <sub>8</sub> '' 64 - 65 cm

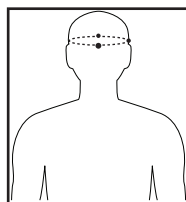

**KOPFUMFANG**

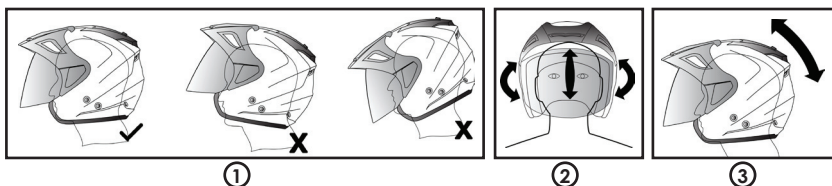

Führen Sie ein Maßband an der breitesten Stelle horizontal um den Kopf. Daraus ergibt sich Ihr Kopfumfang. Normalerweise legt man das Maßband 2.5 cm oberhalb der Augen und Ohren um die Stirn herum. Messen Sie auch knapp unter und über dieser Linie, damit eventuelle Abweichungen berücksichtigt werden, bevor Sie anhand unserer Größentabellen die entsprechende Helmgröße ermitteln. Weiterhin empfiehlt es sich, einen Helm sowohl eine Größe kleiner als auch eine größer als die über die Tabelle bestimmte Größe auszuprobieren. Sitzt der Helm nicht passgenau, kann auch das beste Produkt keinen Schutz bieten.

Helme müssen fest sitzen, dürfen aber nicht drücken. Halten Sie die Kinnriemen beim Aufsetzen des Helms nach außen, damit sie sich nicht im Helminneren verfangen. Ein passender, korrekt sitzender Helm liegt fest, aber komfortabel an und übt gleichmäßigen Druck auf den Kopf aus. Das Innenfutter ist bei den meisten modernen Helmen so konzipiert, dass es zuerst sehr eng anliegt, sich jedoch nach einigen Stunden weitet und an Ihre Kopfform anpasst.

Wenn Sie unsicher sind, ob ein Helm passt oder nicht, fragen Sie am besten einen erfahreneren Fahrer um Rat oder erkundigen Sie sich in dem Geschäft, in dem Sie den Helm gekauft haben. Als Faustregel gilt: Der Helm darf nicht hin und her rutschen, ohne dabei die Haut zu bewegen. Ein locker sitzender Helm ist nicht nur gefährlich, sondern lässt auch Lärm durch und ist anstrengend zu tragen. Helme werden oft zu groß gekauft. **WICHTIG:** Vergewissern Sie sich beim Anprobieren eines Helms, dass der Kinnriemen fest unter dem Kinn angezogen ist. Versuchen Sie dann, den so befestigten Helm vom Kopf zu ziehen. Wenn sich der Helm vorne oder hinten drehen oder mit festgezogenem Kinnriemen abnehmen lässt, ist er zu groß.

Kein Helm kann den Träger vor jedem vorhersehbaren Aufprall schützen. Ein Helm bietet nur der Kopfpartie Schutz, die davon bedeckt ist. Um ein Maximum an Schutz zu bieten, muss der Helm passgenau sitzen und der Kinnriemen fest angezogen sein. Die Nichtbeachtung dieser Anweisungen, der auf dem Helm aufgedruckten und der in der Benutzeranleitung kann bei einem Unfall dazu führen, dass der Helm vom Kopf rutscht und es zu ernsthaften Kopfverletzungen oder zum Tod kommt. Motorrad, Roller, Quads oder Schneemobile zu fahren macht Spaß, kein Zweifel. Der Gefahrenaspekt darf darüber allerdings nicht vernachlässigt werden. Fahren Sie stets verantwortungsbewusst und überschätzen Sie sich nicht.

## **KINNRIEMEN-RÜCKHALTESYSTEM: SCHNELLENTRIEGELUNG**

**WICHTIG:** Vergewissern Sie sich, dass der Kinnriemen des Helms fest unter dem Kinn angezogen ist. Prüfen Sie vor jeder Fahrt, ob der so befestigte Helm vom Kopf gezogen werden kann.

Der Helm darf sich nicht vorne oder hinten drehen oder mit sachgemäß festgezogenem Kinnriemen abnehmen lassen.

Das Rückhaltesystem mit Schnellentriegelung, dessen Zahnsegmente eine Reihe einfacher Einstellungsmöglichkeiten bietet, kann selbst mit dicken Handschuhen ganz leicht betätigt werden. Vergewissern Sie sich vor jeder Fahrt, dass der über das Rückhaltesystem mit Schnellentriegelung individuell eingestellte Helm nicht vom Kopf gezogen werden kann.

Bei der erstmaligen Verwendung des Rückhaltesystems mit Schnellentriegelung befolgen Sie diese Sicherheitsanweisungen bitte Schritt für Schritt. Gehen Sie bei der Anordnung geduldig vor und hetzen Sie nicht. Ist das System erst einmal eingestellt, lässt sich Ihr Helm schnell und sicher aufsetzen. Bis Sie den passenden Sitz für Ihren Helm finden, kann es eine Weile dauern. Sobald das Rückhaltesystem mit Schnellentriegelung aber auf die ideale Passform abgestimmt ist, können Sie ganz rasch feststellen, ob Ihr Helm sicher sitzt.

Setzen Sie den Helm auf und führen Sie den Zahnsteg in die dafür vorgesehene Aussparung ein. Wir empfehlen, den Steg bei der erstmaligen Anpassung etwas über die Hälfte (5 Klicks) einzuführen. Reicht die Länge des Riementeils dazu nicht aus, können Sie es wie in den Abbildungen dargestellt verlängern. Dort wird auch gezeigt, wie Sie ein zu langes Riementeil verkürzen.

Sie dürfen den Riemen auf keinen Fall abschneiden. Ist der schnell entriegelbare Zahnsteg richtig angepasst, sollte er bei aufgesetztem Helm etwas über die Hälfte (5 Klicks) in die Aussparung eingeführt sein. Ein überstehendes Riementeil kann durch die Riemenschnalle zurückgeführt werden. Zur sicheren Befestigung lässt sich die Riemenschnalle an einer beliebigen Stelle am Zahnsteg anbringen.

Die Riemenschnalle darf unter keinen Umständen abgenommen werden. Vergewissern Sie sich beim Verstellen des Riemen über die Riemenschnalle, dass Sie ihn sachgemäß zurückführen – das lose Ende muss nach außen zeigen und wird wie abgebildet durch die Schnalle gefädelt. Die Riemenschnalle verhindert, dass der Riemen vom Zahnsteg zurückrutscht. Die nicht sachgemäße Verwendung der Riemenschnalle kann zum Versagen des Rückhaltesystems und der Schutzwirkung des Helms im Falle eines Unfalls führen.

Stellen Sie anhand der Abbildungen sicher, dass Sie den Riemen sachgemäß festgezogen haben. Und auch auf die Gefahr hin, uns zu wiederholen: Fahren Sie niemals los, ohne den Kinnriemen und das Rückhaltesystem wie abgebildet geschlossen zu haben. Zur Erinnerung: Vergewissern Sie sich vor jeder Fahrt, dass der über das Rückhaltesystem mit Schnellentriegelung individuell eingestellte Helm nicht vom Kopf gezogen werden kann.

Zum Öffnen des Kinnriemens heben Sie den Steg an der Aussparung gemäß der unteren Abbildung an. Nun können Sie den Zahnsteg herausziehen. Überprüfen Sie den Kinnriemen und das Rückhaltesystem entweder vor oder nach jeder Fahrt. Sobald Verschleißerscheinungen erkennbar sind, muss der Helm sofort ersetzt werden. Fahren Sie niemals mit einem Helm, der abgenutzt aussieht, beschädigt ist oder bei dem der Kinnriemen oder Teile des Rückhaltesystems fehlen. Nehmen Sie keinerlei Änderungen am Kinnriemen oder am Rückhaltesystem vor.

### SCHLIESSEN DES KINNRIEMENS

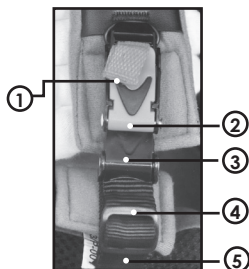
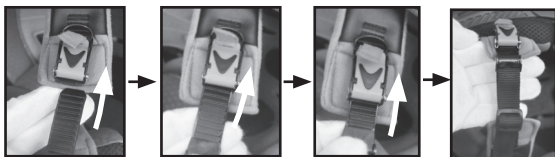

### ÖFFNEN DES KINNRIEMENS

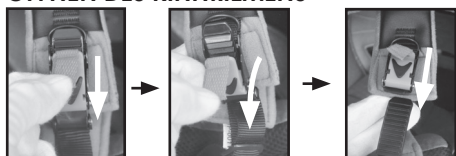

- ① ZUGBAND
- ② RATSCHENSCHLOSS
- ③ RATSCHENZUNGE
- ④ METALLSCHNALLE
- ⑤ KINNRIEMEN

Vergewissern Sie sich bitte, dass der Kinnriemen und das Rückhaltesystem wie oben beschrieben festgezogen wurden. Andernfalls kann es zu tödlichen Verletzungen kommen.

## INNENPOLSTER: WANGENPOLSTER UND KOMFORTPOLSTER

Die Innenfutter und Wangenpolster von AFX-Helmen bestehen aus hypoallergenem, antimikrobiellem Nylon. Sie können fast alle abgenommen und gewaschen werden.

Die Größe eines Helms basiert auf der Kombination von vier Faktoren: Größe der Außenschale, Stärke der Polystyrol-Innenschale, Stärke der Wangenpolster und Stärke der Innenpolster. Sie können die Passform des Helms variieren, indem Sie die vorhandenen Wangenpolster durch dünnere Wangenpolster (für einen gelockerten Sitz) bzw. dickere Wangenpolster (für einen festeren Sitz) ersetzen. Um die Passform noch weiter zu verändern, können Sie das vorhandene Komfortpolster durch ein dünneres Komfortpolster (für einen gelockerten Sitz) bzw. ein dickeres Komfortpolster (für einen festeren Sitz) ersetzen.

In der Tabelle unten sehen Sie, inwieweit Außenschalen, Polster und Wangenpolster miteinander kompatibel sind. Beachten Sie bitte, dass sämtliche Komponenten nur durch Teile desselben Größenbereichs ersetzt werden können.

Wenn Sie Ihren Helm individuell anpassen möchten, müssen Sie außerdem die im Rahmen der Größenbestimmung erwähnten Anweisungen berücksichtigen.

HELMAUSSENSCHALE & EPS-GRÖSSE	XS	S	M	L	XL	XXL
STÄRKE WANGENPOLSTER(MM)	48	44	40	36	32	28
STÄRKE KOPFPOLSTER (MM)	12	10	12	8	8	4



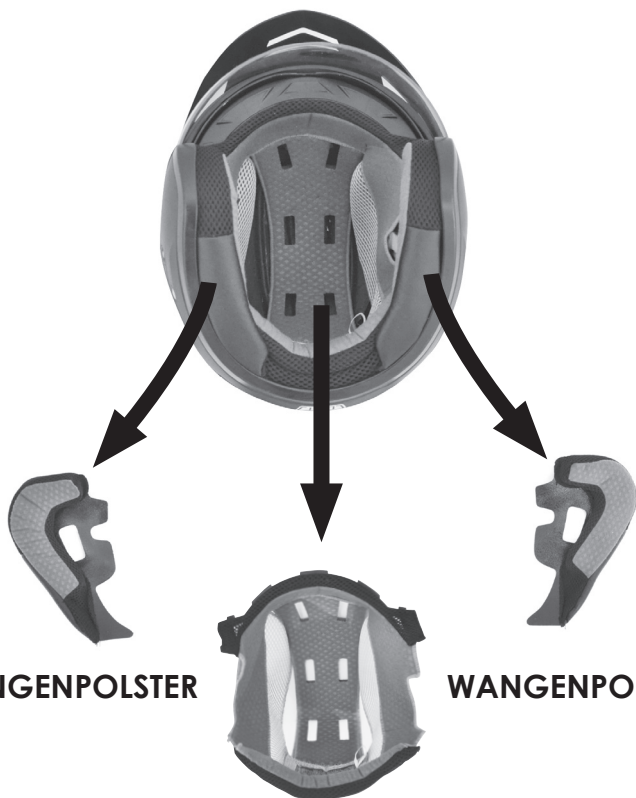

**WANGENPOLSTER**

**WANGENPOLSTER**

**KOMFORT KOPFPOLSTER**

# HERAUSNEHMEN DES KOMFORTPOLSTERS

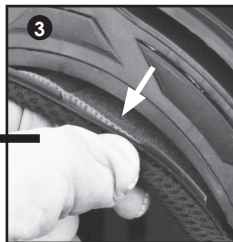
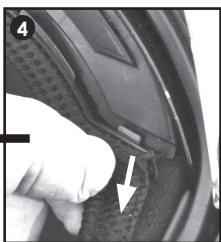
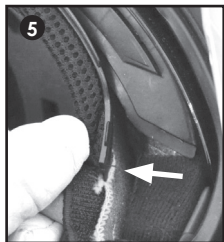
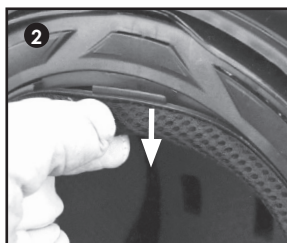
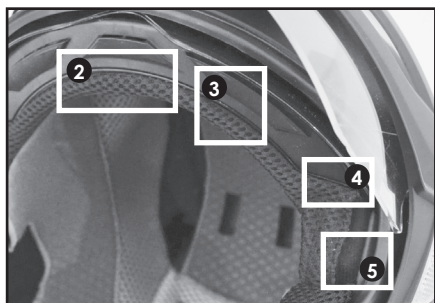
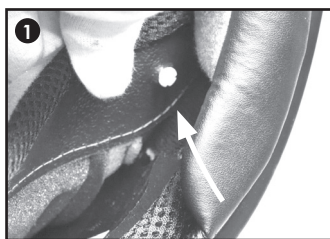
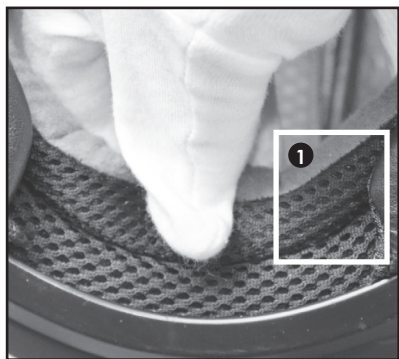

Führen Sie zum Einbauen des Komfortpolsters die Schritte 1 bis 5 in umgekehrter Reihenfolge durch.

# HERAUSNEHMEN DER WANGENPOLSTER

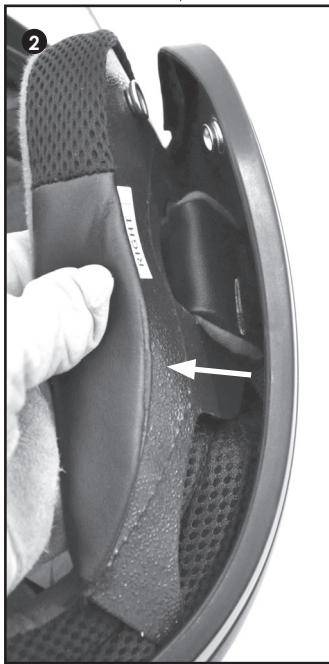
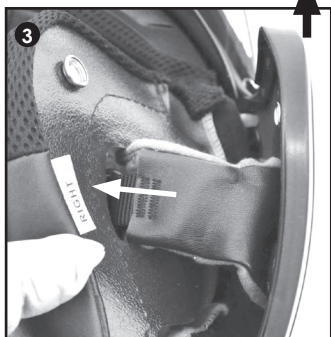
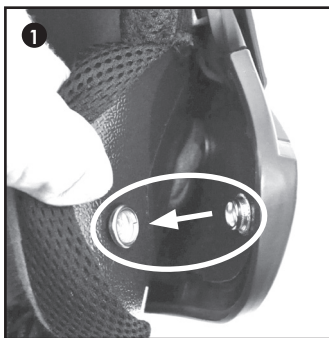
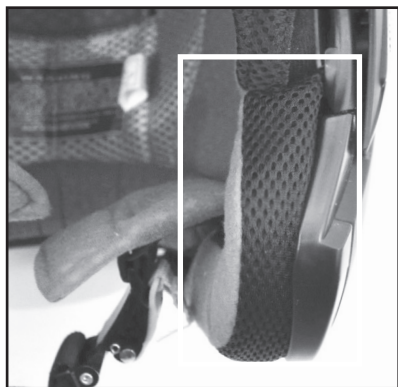

Führen Sie zum Einbauen der Wangenpolster die Schritte 1 bis 4 in umgekehrter Reihenfolge durch.

# ENTFERNEN DES SONNENSCHILDS

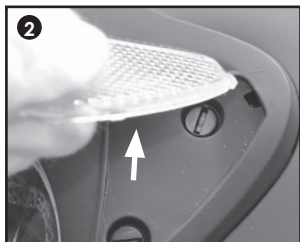
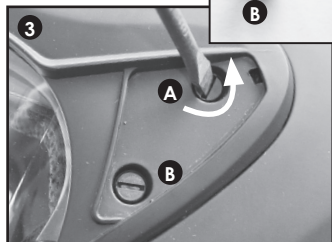
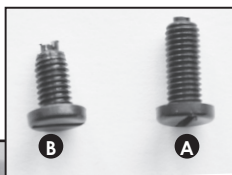
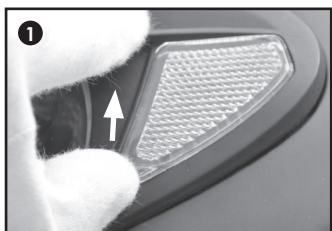
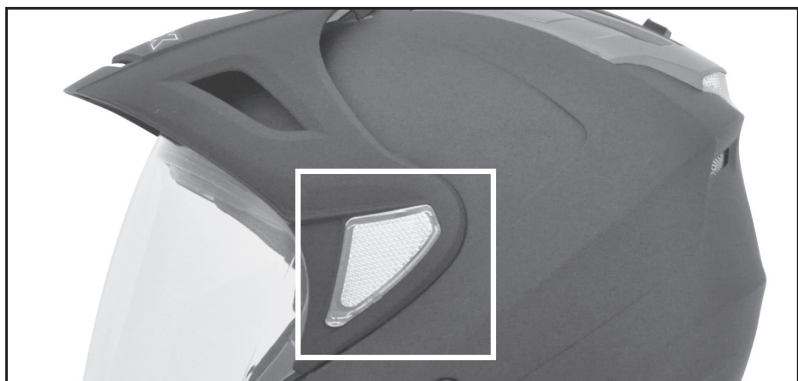

Zur Befestigung des Sonnenschildes Führen Sie Punkte 1 bis 4 in umgekehrter Reihenfolge aus

# ENTFERNEN DES VISIERS

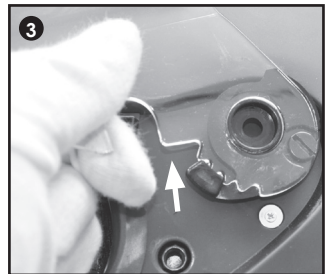
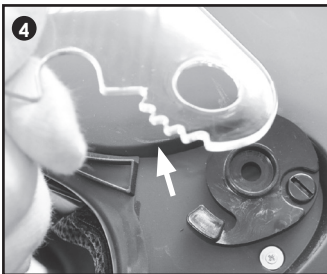
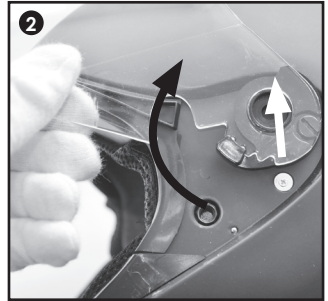
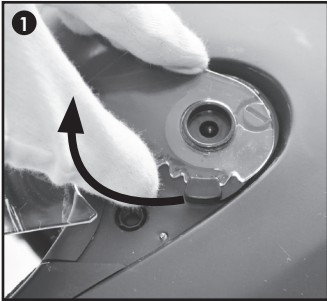
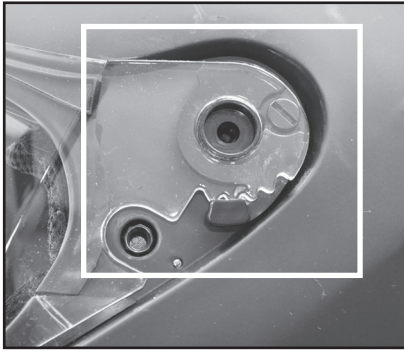

Zur Befestigung des Visiers führen Sie Punkte 1 bis 4 in umgekehrter Reihenfolge aus

# VISIER-MONTAGE

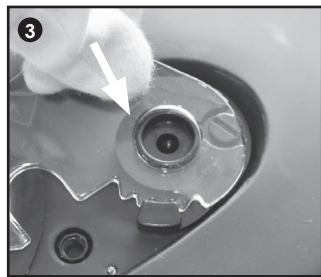
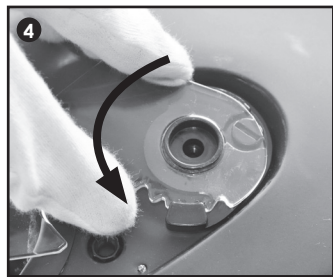
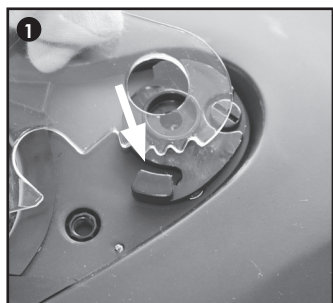
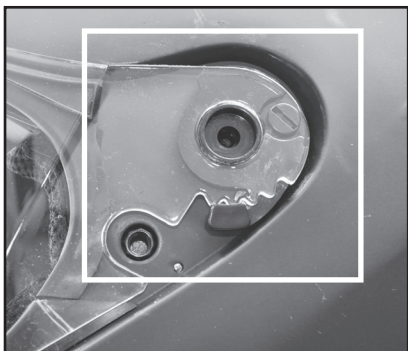

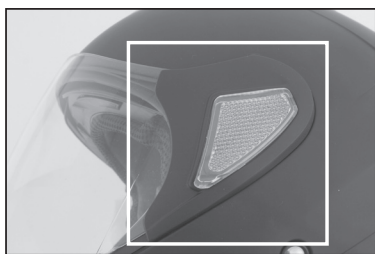
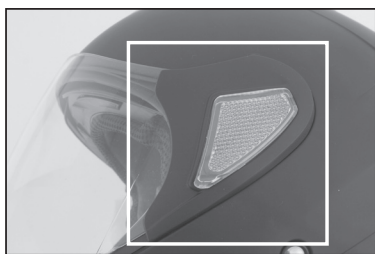
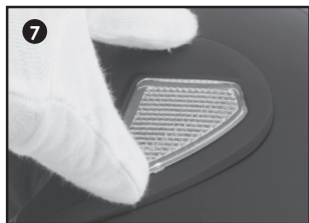
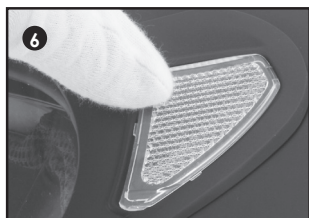
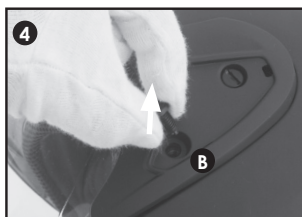
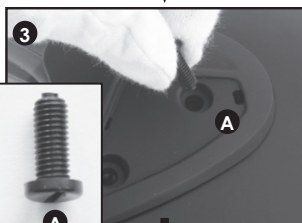
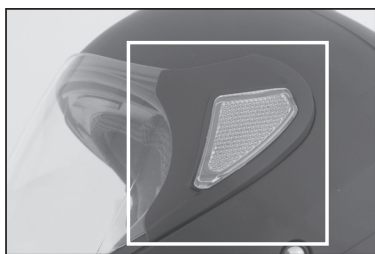

Zum Entfernen der Visiermechanik-Abdeckung führen Sie die Punkte 1 bis 7 in umgekehrter Reihenfolge aus

# ENTFERNEN DES SONNENVISIERS

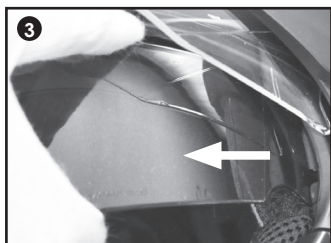
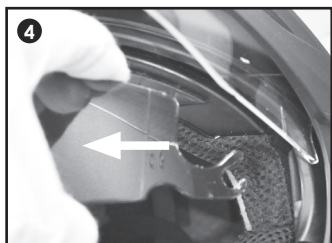
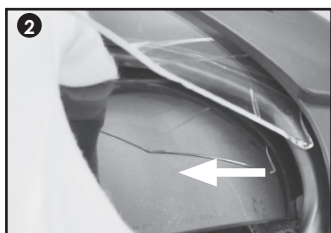
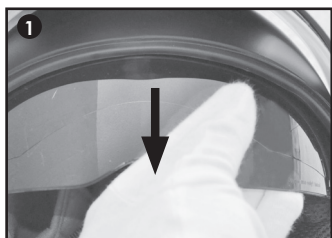
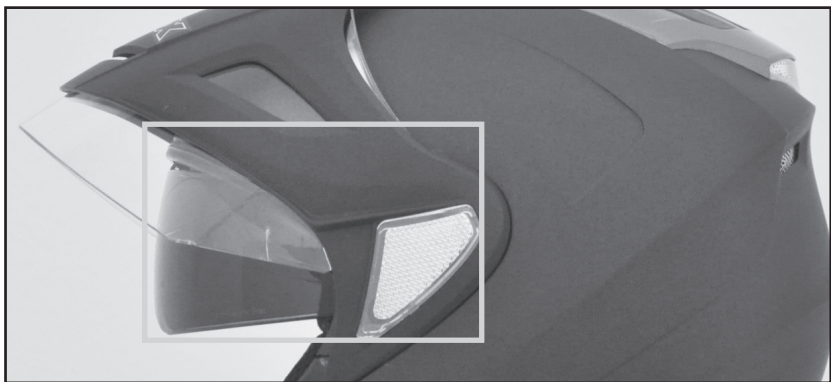



# BEFESTIGUNG DES VISIERS

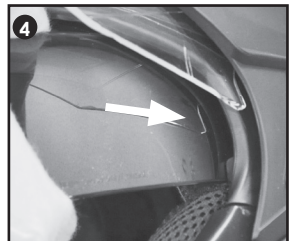
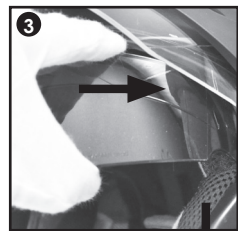
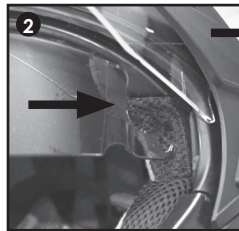
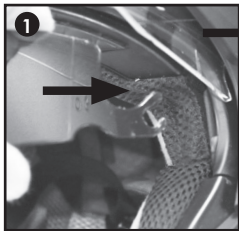
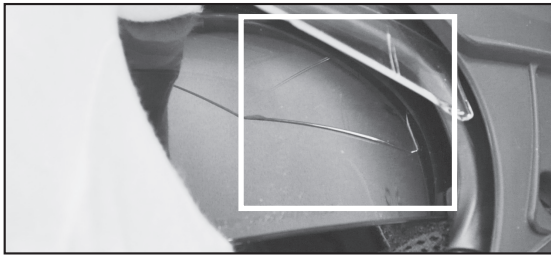

# ÖFFNEN/SCHLIESSEN DES SONNENVISIERS

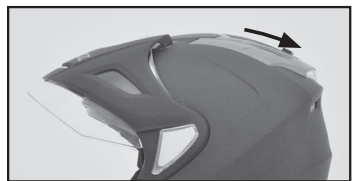
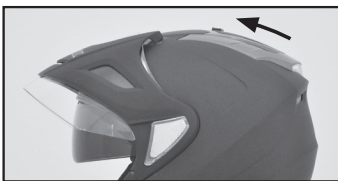

# ÖFFNEN/SCHLIESSEN DES VISIERS

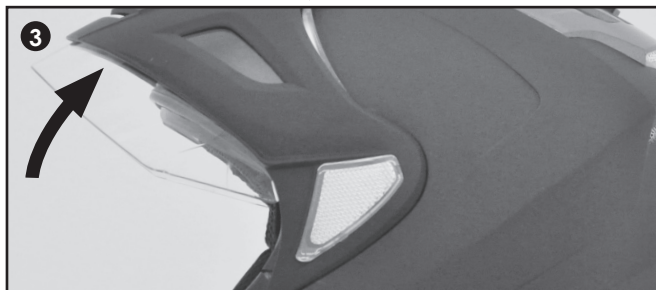
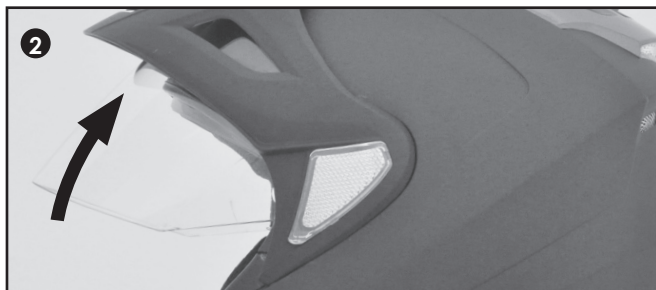
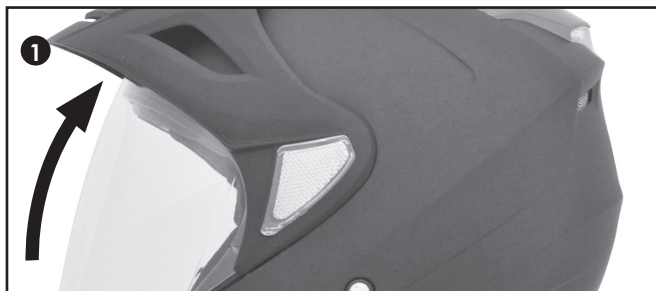

**Zum Schliessen des Visiers führen Sie die Punkte 1 bis 3 in umgekehrter Reihenfolge aus**

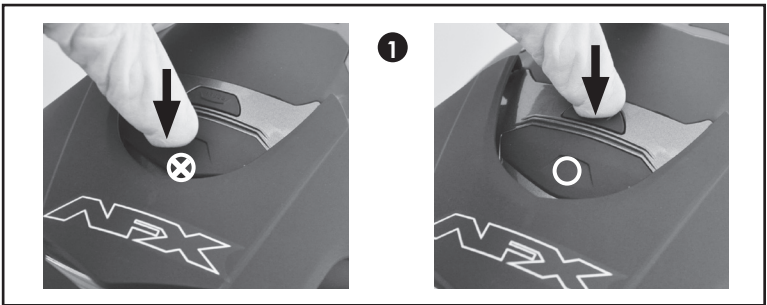
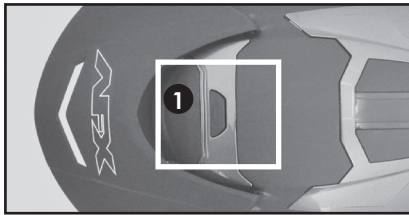

# PFLEGE UND REINIGUNG IHRES AFX-HELMS

Reinigen Sie das Innenfutter des Helms ausschließlich mit Wasser und milder Seife. Wir empfehlen dazu eine milde Seifenlauge mit warmem, aber nicht heißem Wasser. Spülen Sie das Innere des Helms anschließend mit kaltem Wasser aus und lassen Sie es bei Zimmertemperatur trocknen. Starke Hitze und chemische Reinigungsmittel schädigen das Innenfutter. Die Verwendung der folgenden Mittel kann zu Schäden am Helm führen, die äußerlich nicht sichtbar sind:

- Benzin, Öl, Flüssigkeiten auf Mineralölbasis und Lösungsmittel
- Aggressive, abschleifende Reinigungsmittel
- Farbstoffe
- Klebstoffe

Um die Helmlackierung zu schützen, können Wachspolituren für Autos auf farbige Oberflächen der Helmaußenschale aufgetragen werden. Verwenden Sie nur Wachse, die für klar lackierte Oberflächen geeignet sind. Hat der Helm ein Visier, reinigen Sie dieses bitte ausschließlich mit milder Seife und warmem Wasser. Trocknen Sie es mit einem weichen Tuch ab. Wischen Sie das Visier niemals mit Papier- oder Taschentüchern ab. Setzen Sie keinesfalls Glasreiniger ein, es sei denn, Sie verwenden ein für Plastikoberflächen geeignetes Produkt. Lesen Sie bitte sämtliche Warnhinweise auf Schutz- oder Reinigungsmitteln, bevor Sie sie verwenden.

## AUFBEWAHRUNG IHRES AFX-HELMS

Lagern Sie den Helm an einem geschützten Ort. Bewahren Sie ihn im mitgelieferten Helmbeutel oder in einer separat erhältlichen, gut belüfteten Tragetasche auf. Weitere Informationen dazu finden Sie auf [afxhelmets.com](http://afxhelmets.com).

Helme halten zwar viel aus, müssen aber sachgemäß aufbewahrt werden, damit die Schale und die Stabilität nicht in Mitleidenschaft gezogen werden. Treffen Sie entsprechende Schutzvorkehrungen. Wir raten allerdings davon ab, den Helm über einen längeren Zeitraum nicht zu benutzen. Die Anbringung oder Auswechslung eines Visiers oder einer Sonnenblende sollte bei Zimmertemperatur erfolgen, weil extreme Kälte zu Rissen führen kann.

Beachten Sie, dass Tiere von Salz, das sich durch Schwitzen im Helm ansammelt, angezogen werden und möglicherweise versuchen, am Innenfutter und an den Wangenpolstern zu nagen. Bewahren Sie Ihren Helm daher für Tiere unzugänglich auf.

# WICHTIGE SICHERHEITSWARNUNG

AFX empfiehlt, jeden Helm, dessen Außenhülle einem Schlag ausgesetzt wurde, nicht weiter zu verwenden, ganz egal, ob äußerliche Schäden erkennbar sind. Ein Helm ist so konzipiert, dass er sich im Falle eines Unfalls verformt und so die Energie des Aufpralls absorbiert. Er darf danach nicht weiter verwendet werden, da die volle Schutzwirkung nicht mehr gewährleistet ist. Ein Helm kann selbst dann äußerlich nicht erkennbare Schäden davontragen, wenn er versehentlich fallengelassen wird.

Falls Sie glauben, dass Ihr Helm auf irgendeine Weise beschädigt worden sein könnte, ersetzen Sie ihn umgehend durch einen passenden neuen Helm. Wenn Sie nicht sicher sind, was zu tun ist, wenden Sie sich bitte über die AFX-Website an uns. [Afxhelmets.com](http://Afxhelmets.com)

Das Tragen eines Helms macht Sie nicht unverletzbar. Fahren Sie stets verantwortungsbewusst und überschätzen Sie sich nicht.

## ERSATZEMPFEHLUNG FÜR DEN HELM

Ein Helm von AFX hält bei saisonalem Gebrauch vier bis fünf Jahre lang. Diese Lebensdauer verringert sich, wenn er häufiger genutzt wird. Helme, die im Rennsport verwendet werden, sollten aufgrund der stärkeren Beanspruchung in kürzeren Intervallen ausgetauscht werden. Je häufiger ein Helm den Naturelementen und Körperflüssigkeiten ausgesetzt ist, desto eher tritt Verschleiß ein. Die erste Komponente, bei der Verschleiß festgestellt wird, ist meistens das Innenfutter. Dies ist ein Hinweis, den Helm zu ersetzen. Wenn Sie nicht sicher sind, ob Ihr Helm ersetzt werden sollte, wenden Sie sich bitte über die AFX-Website an uns. [Afxhelmets.com](http://Afxhelmets.com)

Vielen Dank, dass Sie einen AFX-Helm gekauft und sich die Zeit genommen haben, diese Benutzeranleitung durchzulesen. Die Anleitung und andere nützliche Informationen können von unserer Website [afxhelmets.com](http://afxhelmets.com) heruntergeladen werden.

## **IMPORTANTE: LEA ESTE MANUAL COMPLETO ANTES DE UTILIZAR EL CASCO AFX**

Gracias por comprar el casco AFX. El casco AFX ha sido diseñado para que pueda utilizarlo cómodamente durante años. Si respeta las siguientes indicaciones, podrá sacar el máximo partido de su nuevo casco.

Antes de utilizar su nuevo casco, dedique el tiempo necesario para leer las siguientes instrucciones de uso y cuidado. Si no lee y comprende el contenido de este manual del propietario y sus advertencias, el casco podría no protegerlo en caso de accidente.

## **USO DEL CASCO AFX**

Aunque no existe ningún casco que pueda proteger al usuario contra todos los impactos posibles, las siguientes instrucciones de seguridad le ayudarán a obtener una máxima protección y un uso óptimo de su casco.

1. Para que el casco pueda protegerlo correctamente, su talla debe poder ajustarse correctamente; si le queda demasiado pequeño o demasiado grande, podría no ser seguro. Un casco correctamente ajustado, con la mentonera firmemente fijada, debe quedar ceñido cómodamente. Sentirá una presión uniforme en toda la cabeza (sin espacios). Respecto a la holgura, el casco no debe poder girar libremente hacia atrás o hacia delante, es decir, debe ser imposible de quitar con la mentonera abrochada.
2. La mentonera debe estar bien abrochada en todo momento. No conduzca si la mentonera no está abrochada correctamente. Asegúrese de que permanezca bien ceñido a la cabeza en todo momento (excepto cuando vaya a quitárselo, por supuesto).
3. No realice ninguna modificación y nunca fije nada al casco utilizando tornillos o cualquier tipo de adhesivo. Para mantener la integridad y la eficacia del casco, no realice ninguna modificación en su estructura interna o externa.

El casco solo brinda protección si lo lleva puesto. Por lo tanto, no se olvide de ponérselo antes de conducir. Si siente el viento en el pelo (o lo que quede de él), es posible que se haya olvidado de ponérselo. Deféngase de inmediato y póngase el casco. Además, debe ser de la talla correcta y estar bien ajustado a la cabeza.

## FABRICACIÓN DEL CASCO AFX

Este casco ha sido diseñado y creado conforme a las NORMAS DOT Y ECE, y cumplen o exceden las normas de seguridad para cascos DOT FMVSS 218 (EE. UU./Canadá) y ECE 22-05 (Europa).

Antes de solicitar repuestos o reemplazar piezas del casco que pueda reparar el usuario, consulte el diagrama inferior para familiarizarse con los nombres y términos específicos con que se designan las distintas partes del casco.

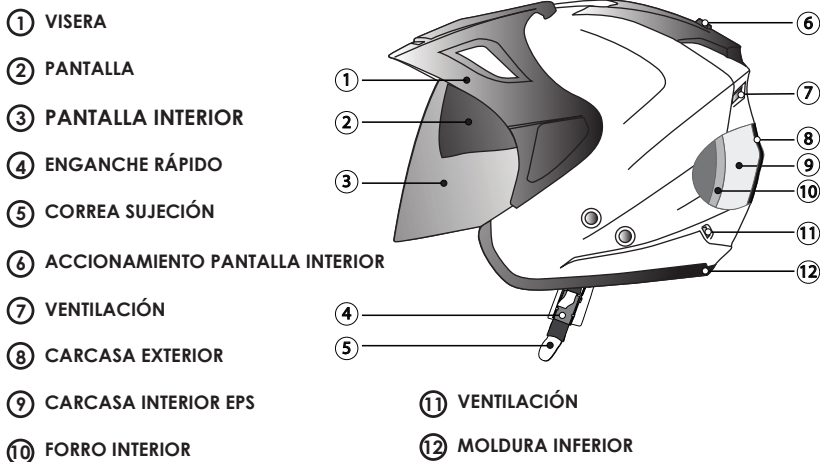

**NO REALICE NINGUNA MODIFICACIÓN EN EL CASCO.** Para que el casco pueda ofrecerle una protección óptima, no debe realizar ninguna modificación en las piezas de su estructura externa o interna ni en las piezas adicionales que lo componen. Muchos tipos de pinturas y adhesivos pueden dañar el casco y dejarlo inservible, aún cuando el usuario no pueda apreciarlo a simple vista. Por lo tanto, no pinte el casco ni pegue nada en él.

# AJUSTE ADECUADO DEL CASCO AFX

## TALLAS DE CASCO

<b>XS</b> 6 <sup>3</sup> / <sub>4</sub> - 6 <sup>7</sup> / <sub>8</sub> hat 21 <sup>1</sup> / <sub>4</sub> - 21 <sup>5</sup> / <sub>8</sub> '' 54 - 55 cm	<b>S</b> 7 - 7 <sup>1</sup> / <sub>8</sub> hat 22 - 22 <sup>7</sup> / <sub>16</sub> '' 56 - 57 cm	<b>M</b> 7 <sup>1</sup> / <sub>4</sub> - 7 <sup>3</sup> / <sub>8</sub> hat 22 <sup>13</sup> / <sub>16</sub> - 23 <sup>1</sup> / <sub>4</sub> '' 58 - 59 cm
<b>L</b> 7 <sup>1</sup> / <sub>2</sub> - 7 <sup>5</sup> / <sub>8</sub> hat 23 <sup>5</sup> / <sub>8</sub> - 24'' 60 - 61 cm	<b>XL</b> 7 <sup>3</sup> / <sub>4</sub> - 7 <sup>7</sup> / <sub>8</sub> hat 24 <sup>3</sup> / <sub>8</sub> - 24 <sup>13</sup> / <sub>16</sub> '' 62 - 63 cm	<b>XXL</b> 8 - 8 <sup>1</sup> / <sub>8</sub> hat 25 <sup>3</sup> / <sub>16</sub> - 25 <sup>5</sup> / <sub>8</sub> '' 64 - 65 cm

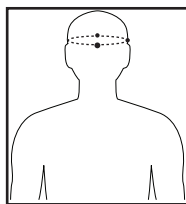

MEDIDA DEL CRÁNEO

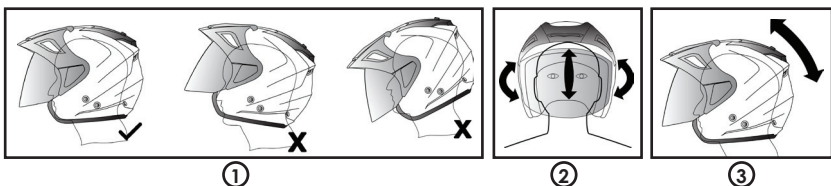

Determine la circunferencia de la parte más ancha de su cabeza con una cinta métrica flexible. Por lo general, la parte más ancha de la cabeza de una persona es la zona que se encuentra a 2,5 cm (1 pulg.) por encima de los ojos y las orejas. Sin embargo, le recomendamos que realice la medición en varios puntos por encima y por debajo de esa línea para determinar la medida más alta antes de consultar las tablas de tallas. También le recomendamos que compruebe el ajuste de un casco de una talla menor y de otro de una talla mayor que la recomendada en la tabla. Ningún casco sirve para protegerlo si llevarlo resulta demasiado incómodo.

Los cascos deben quedar bien ceñidos, pero sin apretar de forma dolorosa. Mientras sujeta las mentoneras fuera del casco, tire de este hacia abajo sobre la cabeza, con cuidado de que las mentoneras no se queden dentro del casco. Si el casco está ajustado correctamente, deberá estar sujeto y ejercer una presión uniforme alrededor de la cabeza y en la parte superior de esta. En la mayoría de los cascos modernos, el forro está diseñado para quedar un poco más ajustado al principio, pero cederá tras conducir durante varias horas hasta adaptarse a la forma de la cabeza.



Si no está familiarizado con el ajuste del casco y la sensación que este debe producir, asegúrese de consultar a un motociclista con más experiencia o al punto de venta en el que lo adquirió. Como regla general, el casco no debe girar alrededor de la cabeza sin tirar de la piel. Utilizar un casco holgado no solo es peligroso, sino que también puede resultar ruidoso e incómodo. La mayoría de las personas cometen el error de comprar cascos demasiado grandes. **IMPORTANTE:** asegúrese de abrochar bien la mentonera debajo de la barbilla al probarse un casco y, a continuación, compruebe que, mientras está sujeto de esa forma, el casco no puede desprenderse de la cabeza. Respecto a la holgura, el casco no debe poder girar libremente hacia atrás o hacia adelante, es decir, debe ser imposible de quitar con la mentonera abrochada.

No existe ningún casco capaz de proteger al usuario frente a todos los impactos posibles. Los cascos solamente pueden proteger la parte de la cabeza cubierta por el casco. Para conseguir la máxima protección, el casco debe estar bien ajustado con la mentonera firmemente sujeta. Si no se respetan estas instrucciones, las impresas en el casco y las que figuran en el manual del propietario, el casco podría desprenderse en caso de accidente, por lo que podrían producirse lesiones graves en la cabeza o incluso la muerte. Aunque conducir motocicletas, scooters, vehículos todoterreno y motonieves es divertido, también puede ser un pasatiempo peligroso. En AFX, le animamos a disfrutar de la conducción de forma responsable, así como a viajar respetando siempre los límites de su capacidad.

**IMPORTANTE:** asegúrese de que la mentonera esté siempre bien abrochada debajo de la barbilla al utilizar el casco. Antes de conducir, compruebe que no puede quitarse el casco de la cabeza cuando está sujeto de esa manera.

El casco no debe estar desgastado ni tan aflojado como para girar libremente hacia atrás o hacia delante y desprenderse de la cabeza con la mentonera abrochada correctamente.

El sistema de retención con liberación rápida del casco permite que el conductor pueda desabrocharlo y quitárselo con guantes gruesos, y ofrece una gran capacidad para ajustarlo de forma sencilla gracias al sistema de trinquete. Antes de conducir, compruebe que sea imposible quitarse el casco cuando el sistema de retención con liberación rápida esté ajustado específicamente para su talla de cabeza.

Para ajustar con firmeza el sistema de retención con liberación rápida por primera vez, siga estas importantes instrucciones de ajuste de seguridad. Dedique el tiempo necesario a llevar a cabo este procedimiento; una vez completado y configurado correctamente, podrá fijar el casco de forma práctica y cómoda. Aunque es posible que necesite realizar varios intentos para conseguir el ajuste más adecuado en función de sus necesidades, una vez que el sistema de retención con liberación rápida esté configurado correctamente, le ofrecerá una manera rápida y cómoda de asegurarse de que el casco está fijado correctamente y de forma segura.

Colóquese el casco e inserte la lengüeta de trinquete en el receptor de trinquete. Le recomendamos que introduzca más de la mitad de la lengüeta (5 chasquidos) en el receptor para establecer el ajuste específico de forma inicial. Si la correa no es suficientemente larga, siga las ilustraciones para ver cómo puede alargarla. Por el contrario, si la correa es demasiado larga, siga las ilustraciones con instrucciones para acortarla.

En ningún caso se debe cortar la correa para acortarla. Para estar ajustado correctamente, cuando tenga el casco puesto la lengüeta de trinquete de liberación rápida debe estar introducida hasta más de la mitad (5 chasquidos) en el receptor de trinquete. La parte sobrante de la correa puede volver a pasarse a través de la hebilla, y esta puede colocarse en cualquier lugar del lado de la lengüeta de trinquete, de modo que permita fijar la correa sobrante.

Bajo ningún concepto deberá quitarse de este sistema la hebilla de la correa. Al ajustar la correa a través de la hebilla, asegúrese siempre de volver a pasarla correctamente para que el extremo suelto quede en el exterior y quede pasado del modo que se indica en la ilustración. La función de la hebilla es evitar que la correa se suelte de la lengüeta de trinquete. Si no se utiliza la hebilla correctamente del modo que se muestra, el sistema de retención podría fallar y el casco perdería la capacidad para protegerle en caso de accidente.

Consulte los diagramas para asegurarse de que la correa esté apretada correctamente. Asimismo, como siempre, no conduzca si la mentonera y el sistema de retención no están apretados correctamente del modo correcto indicado en la ilustración. A modo de recordatorio, antes de conducir, asegúrese de que es imposible quitarse el casco cuando el sistema de retención esté ajustado para su talla.

Para quitar la mentonera, levante la anilla de apertura del receptor de trinquete como se muestra en el siguiente diagrama. A continuación, puede tirar de la lengüeta de trinquete para extraerla. Asegúrese siempre de inspeccionar la mentonera y el sistema de retención antes o después de conducir. Si la mentonera o el sistema de retención presentan algún signo de desgaste, debe reemplazar el casco de inmediato. Nunca conduzca con un casco desgastado, dañado, sin mentoneras o al que le falten piezas del sistema de retención. No realice modificación alguna en la mentonera o en el sistema de retención.

#### AJUSTAR CORREA

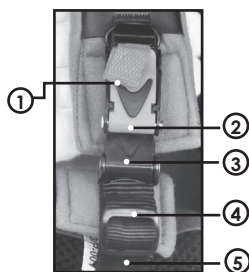
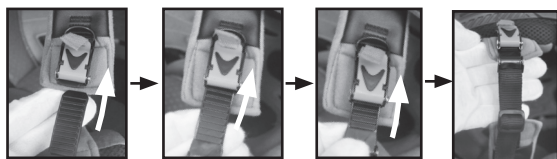

#### LIBERAR CORREA

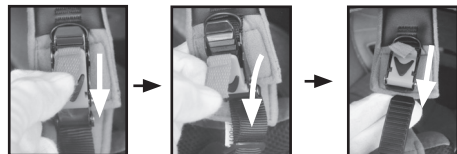

- ① LENGÜETA LIBERACIÓN
- ② RECEPTOR TRINQUETE
- ③ TRINQUETE
- ④ HEBILLA DE CORREA
- ⑤ CORREA SUJECCIÓN

Asegúrese de que la mentonera y el sistema de retención siempre estén abrochados conforme a las instrucciones anteriores. En caso contrario, podrían producirse lesiones graves o mortales.

## INTERIOR: CARRILLERAS Y FORRO DE CONFORT

Las carrilleras y los forros de confort del casco AFX son de nailon hipoalérgico y antimicrobiano (en su mayoría desmontables y lavables).

La talla del casco se basa en la combinación de cuatro factores: el tamaño de la carcasa externa, el grosor del acolchamiento interno de PES, el grosor del forro de confort y el grosor de las carrilleras. El ajuste del casco puede adaptarse de modo personalizado reemplazando las carrilleras por otras más finas (para que queden menos apretadas) o más gruesas (para que queden más apretadas). Asimismo, también puede adaptarse sustituyendo el forro de confort existente por otro más fino (para que quede menos apretado) o por otro más grueso (para que quede más apretado).

Consulte el cuadro de compatibilidad de la carcasa, el forro y las carrilleras, y recuerde que estos componentes solamente pueden reemplazarse por otros comprendidos dentro del grupo de tallas de cada bloque de intervalos de tallas.

Asimismo, si desea aprovechar la capacidad de personalización del ajuste del casco, tenga en cuenta las instrucciones presentadas anteriormente en el manual de ajuste adecuado.

CARCASAS Y TALLAS DE CASCO	XS	S	M	L	XL	XXL
GROSOR ALMOHADILLAS (MM)	48	44	40	36	32	28
GROSOR FORRO INTERIOR (MM)	12	10	12	8	8	4

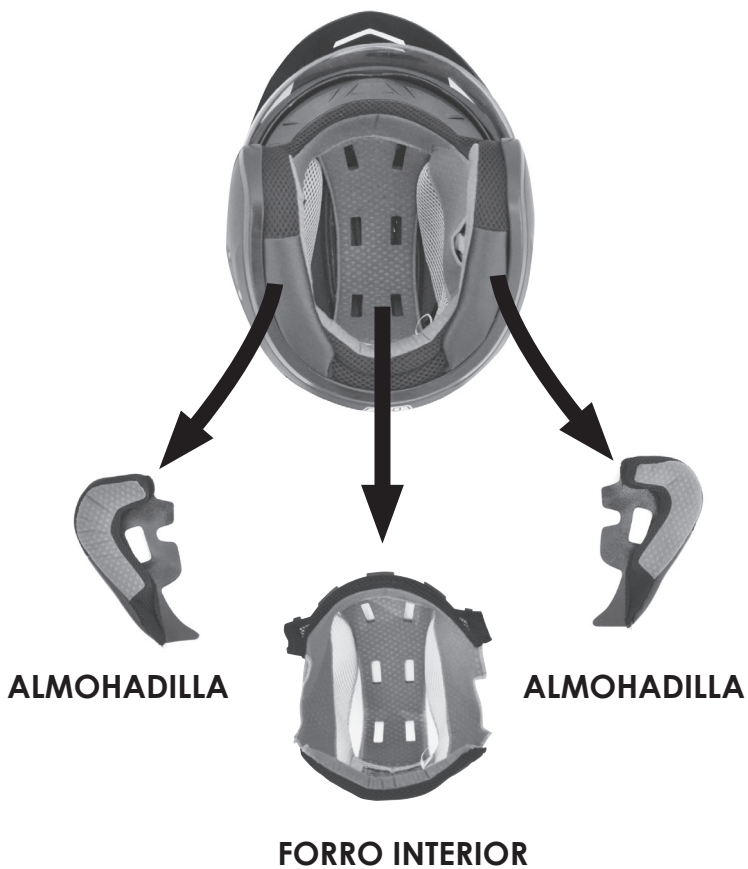

# RETIRADA DEL FORRO DE CONFORT

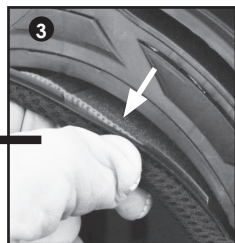
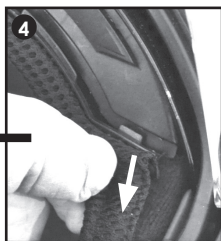
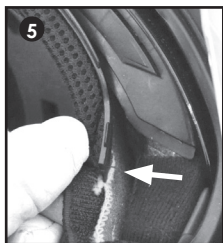
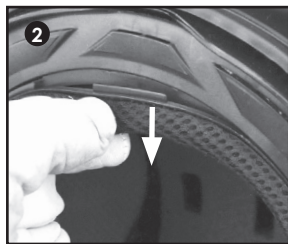
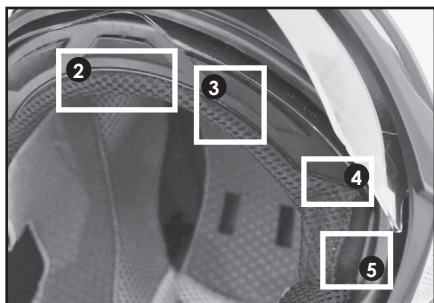
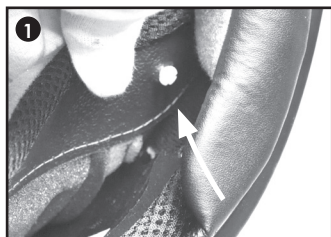
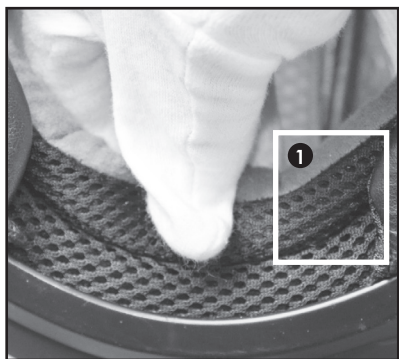

Para volver a colocar el forro de confort, invierta los pasos del 1 al 5.

# RETIRADA DE LA CARRILLERA

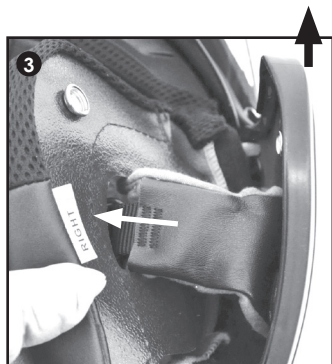
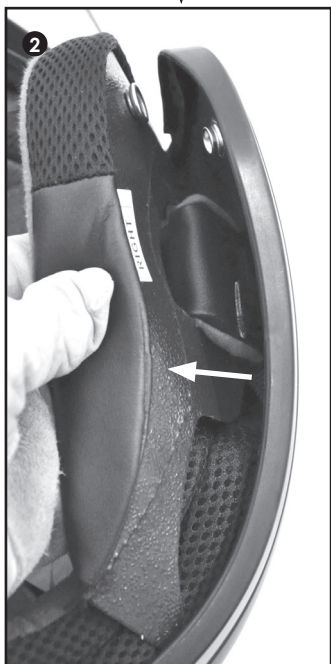
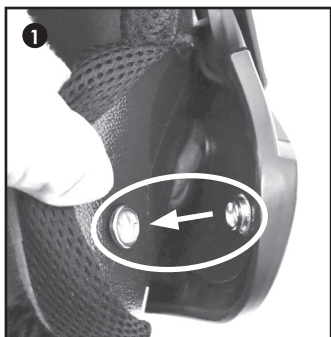
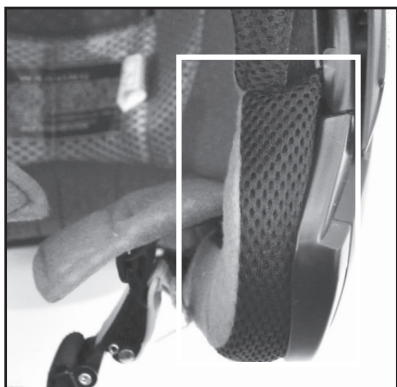

Para volver a colocar la carrillera, invierta los pasos del 1 al 4.

# DESMONTAJE DE LA VISERA

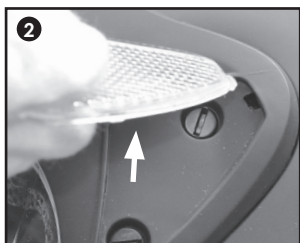
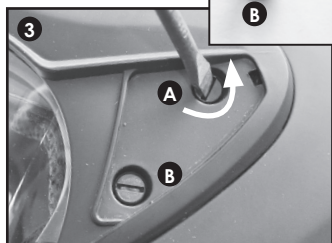
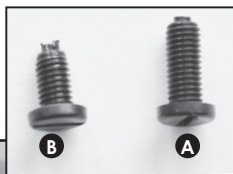
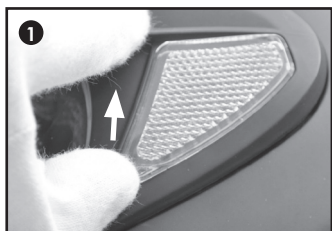
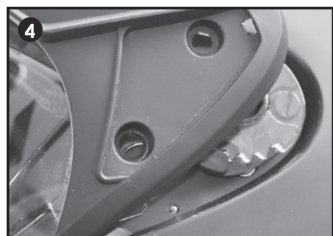
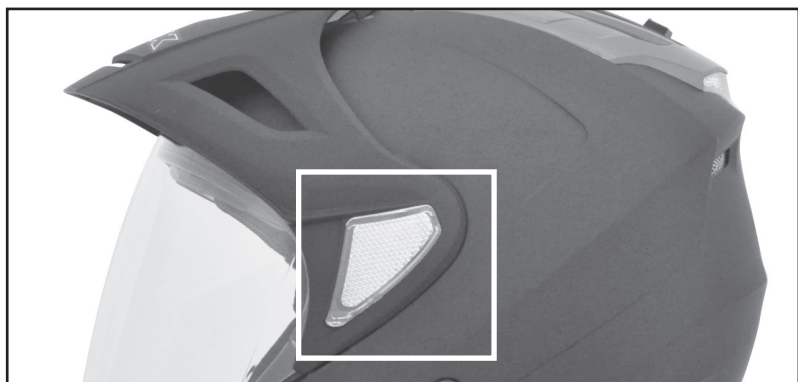

Para reinstalar la visera, invierta los pasos 1-4.



# DESMONTAJE DE LA PANTALLA

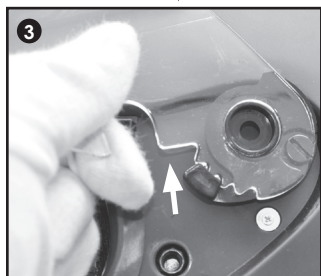
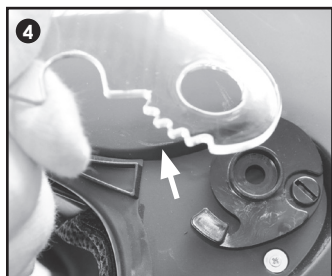
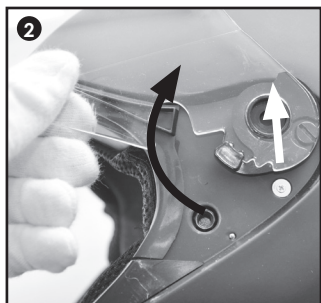
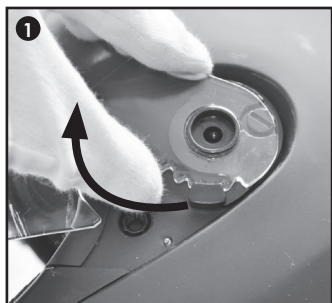
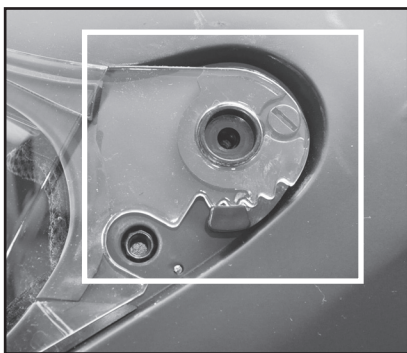

Para reinstalar la pantalla, invierta los pasos 1-4.

# INSTALACIÓN DE LA PANTALLA

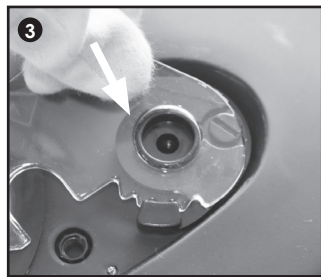
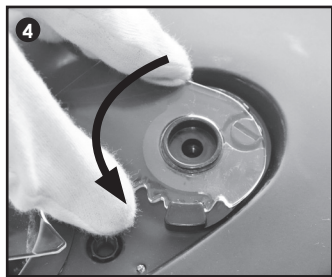
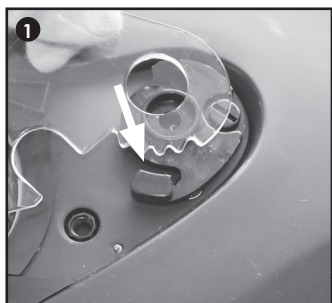
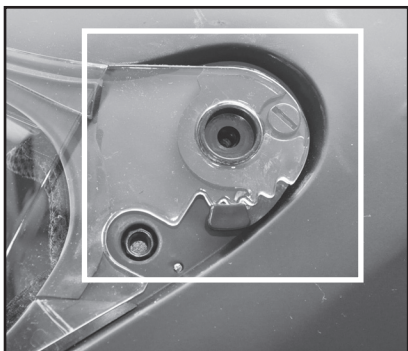

# DESMONTAJE/INSTALACIÓN TAPAS LATERALES

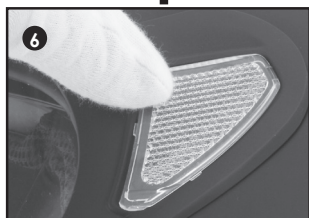
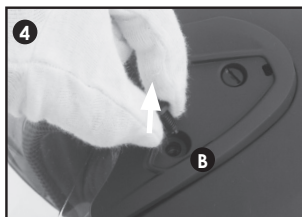
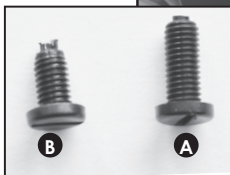
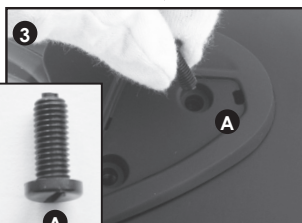
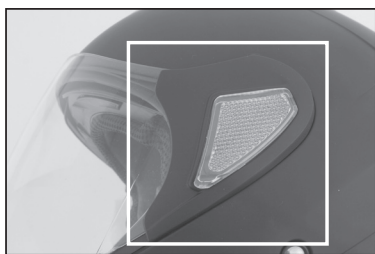

Para reinstalar las tapas laterales, invierta los pasos 1-7.

# DESMONTAJE DE LA PANTALLA INTERIOR

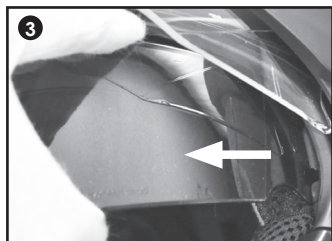
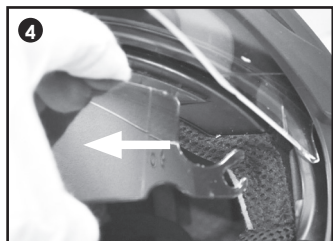
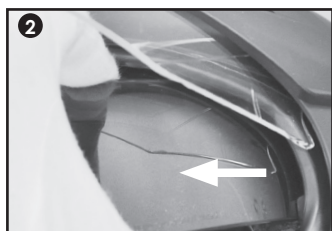
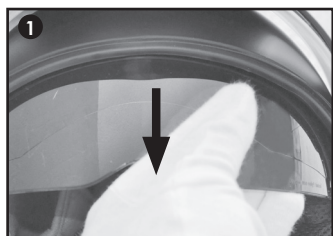
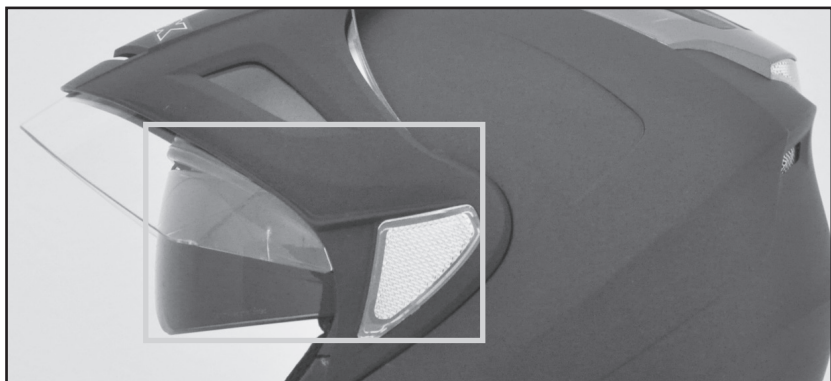

# INSTALACIÓN DE LA PANTALLA INTERIOR

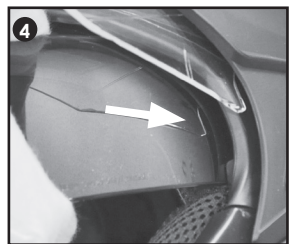
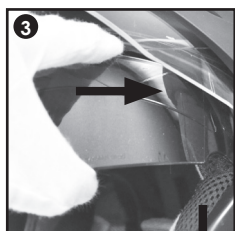
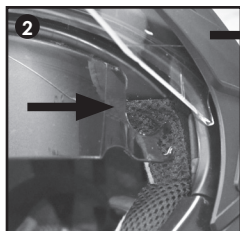
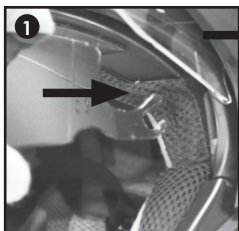
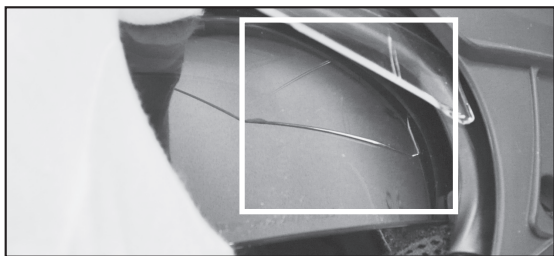

# SUBIR/BAJAR LA PANTALLA INTERIOR

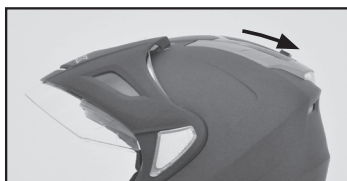
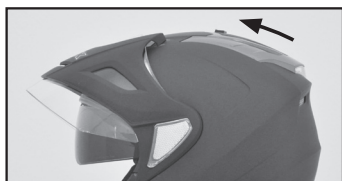

# ABRIR/CERRAR LA PANTALLA

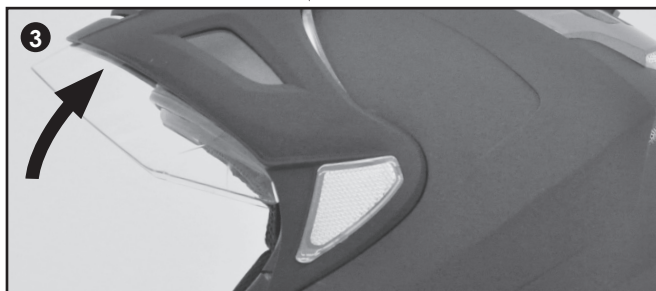
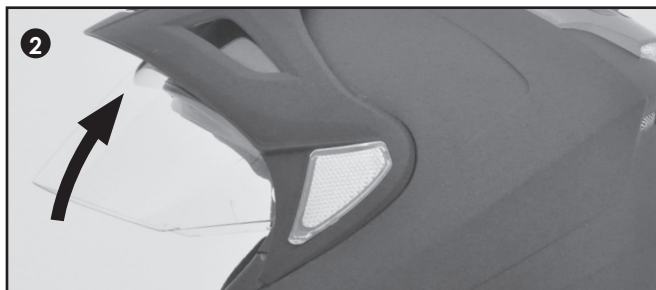
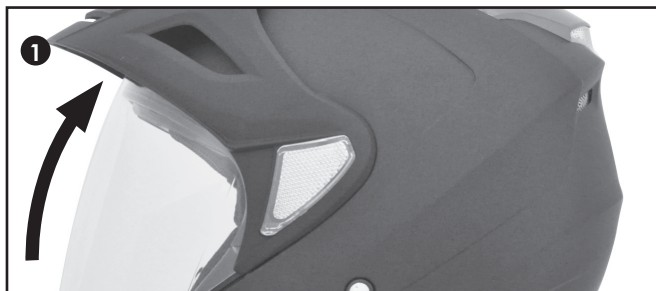

Para cerrar la pantalla, invierta los pasos 1-3

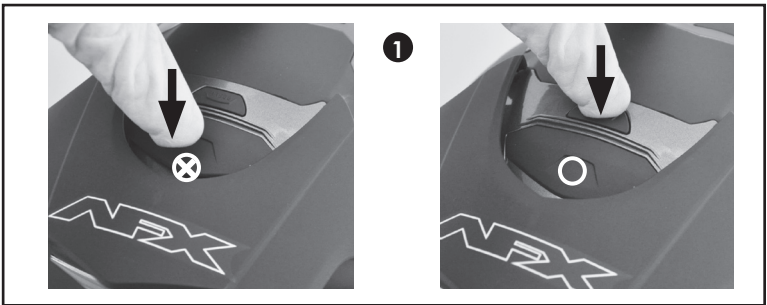
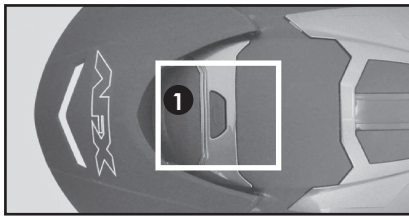

# CUIDADO Y LIMPIEZA DEL CASCO AFX

Limpie el forro del casco únicamente con jabón suave y agua. Le recomendamos que utilice una solución de jabón líquido suave y agua tibia (no caliente). Tras limpiar el interior del casco, enjuáguelo con agua fría y deje que se seque al aire libre a temperatura ambiente. Las altas temperaturas y el uso de disolventes de limpieza fuertes pueden dañar el forro. Los siguientes productos pueden dañar el casco sin que los daños sean visibles:

- Líquidos y disolventes con gasolina, aceite o petróleo
- Compuestos de limpieza abrasivos o duros
- Pinturas
- Adhesivos

Puede aplicar ceras para automóviles a las superficies pintadas de la carcasa del casco para proteger el acabado. Utilice únicamente ceras adecuadas para acabados pintados con revestimiento transparente. Si el casco tiene pantalla, le recomendamos que utilice únicamente jabón suave y agua tibia, y que la seque con un paño suave. No utilice pañuelos ni toallas de papel para limpiar las pantallas. Asimismo, no utilice limpiacristales comerciales de ningún tipo. No obstante, puede utilizar determinados limpiacristales si han sido aprobados para superficies de plástico. Lea todas las etiquetas de advertencia de los protectores o los limpiadores antes de utilizarlos en el casco.

# ALMACENAMIENTO DEL CASCO AFX

Guarde el casco en lugar seguro cuando no vaya a utilizarlo. Le recomendamos que lo guarde en la bolsa protectora suministrada con el casco. También comercializamos una bolsa opcional de transporte con ventilación segura. Visite [afxhelmets.com](http://afxhelmets.com) para obtener más información

Aunque los cascos son resistentes, para conservar su aspecto e integridad es necesario protegerlos si va a guardarlos durante un periodo de tiempo prolongado. No obstante, no es recomendable guardar el casco durante un periodo de tiempo prolongado (sobre todo si tenemos en cuenta lo divertido que es ir en moto). Las viseras o pantallas deben instalarse o sustituirse a temperatura ambiente, ya que estos elementos pueden agrietarse a temperaturas muy bajas.

Tenga en cuenta que los animales de compañía se sienten atraídos por la sal acumulada por la transpiración y pueden sentir el deseo de morder el forro y las carrilleras del casco. Por extraño que parezca, esto ocurre. Así que ya sabe: alimente a sus mascotas con comida y no con cascos.



# ADVERTENCIAS DE SEGURIDAD IMPORTANTES

En AFX le recomendamos que deje de utilizar inmediatamente cualquier casco que haya sufrido algún impacto en la carcasa, tanto si presenta daños físicos visibles como si no. Los cascos están diseñados para deformarse en caso de accidente con el fin de absorber la energía del impacto, por lo que nunca deben volver utilizarse, ya que podrían haber perdido su capacidad para proteger al conductor. También es posible que, si el casco se cae por accidente al suelo o sobre cualquier otro tipo de superficie dura, sufra daños que el conductor no pueda apreciar a simple vista.

Si sospecha que la integridad del casco se ha visto afectada de algún modo, deje de utilizarlo de inmediato y busque un sustituto adecuado. Si no está seguro de qué debe hacer, póngase en contacto con AFX a través de nuestro sitio web. [Afxhelmets.com](http://Afxhelmets.com)

Asimismo, debe ser consciente de que el uso de un casco no le hace indestructible, por lo que le animamos a disfrutar de la conducción de forma responsable, así como a hacerlo siempre dentro de los límites de su capacidad.

## RECOMENDACIÓN DE SUSTITUCIÓN DEL CASCO

La vida útil esperada de los cascos AFX es de 4 a 5 años con un uso regular, y disminuye a medida que aumenta la frecuencia de uso. Como es lógico, los cascos de competición (por ejemplo, para carreras en carretera o en todo terreno) suelen tener una vida útil bastante más corta. Cuanto mayor sea la exposición de un casco a los elementos, a aceites corporales y a la transpiración, más rápido se producirá su desgaste. En la mayoría de los casos, el forro del casco será el primer componente que se desgaste, lo que lo convierte en un buen indicador de la necesidad de reemplazar el casco. Si no está seguro de si es necesario reemplazar el casco, póngase en contacto con AFX a través de nuestro sitio web. [Afxhelmets.com](http://Afxhelmets.com)

Gracias por comprar un casco AFX y dedicar el tiempo necesario para leer este manual del cliente. En [afxhelmets.com](http://afxhelmets.com) puede descargar copias de este manual y otra información importante.

## **PRIMA DI UTILIZZARE IL CASCO AFX, TI CONSIGLIAMO DI LEGGERE ATTENTAMENTE IL MANUALE**

Grazie per aver scelto un casco AFX. Il tuo casco AFX è stato progettato per garantirti anni di utilizzo nel massimo comfort. Se rispetti le istruzioni, sarai in grado di sfruttare al massimo le potenzialità del tuo nuovo casco.

Prima di iniziare a utilizzare il nuovo casco, ti invitiamo a leggere le istruzioni per l'uso e la manutenzione. La mancata lettura e comprensione del contenuto del presente manuale dell'utente e delle relative avvertenze può causare la mancata protezione in caso di incidente. podría no protegerlo en caso de accidente.

## **UTILIZZO DEL CASCO AFX**

Sebbene nessun casco possa proteggerti da tutte le forme possibili di impatto, queste istruzioni di sicurezza ti aiuteranno a sfruttare il tuo casco in termini di potenzialità e protezione.

1. Per proteggerti nel modo previsto, il casco deve essere della misura corretta: un casco troppo grande o troppo piccolo potrebbe non essere sicuro. Invece, un casco della misura corretta e con il cinturino del sottomento ben allacciato, risulterà aderente ma al tempo stesso comodo. Avvertirai una pressione omogenea su tutta la testa. Il casco deve essere allacciato ben stretto in modo da non ruotare liberamente sulla parte anteriore o posteriore e da non poter essere sfilato quando il cinturino del sottomento è allacciato.

2. Il cinturino del sottomento deve essere sempre ben allacciato: non metterti alla guida se non hai allacciato correttamente il cinturino del sottomento. Accertati che sia sempre ben aderente, tranne, naturalmente, quando lo togli.

3. Non alterare in alcun modo il casco e non fissarvi nulla con viti o adesivi. Per preservare l'integrità e l'efficacia del casco, non alterare in alcun modo la sua struttura interna o esterna.

Un casco ti protegge solo se lo indossi. Prima di metterti alla guida, ricorda di indossarlo. Se senti il vento tra i capelli (o quei pochi che ti sono rimasti) forse hai dimenticato di indossarlo. Fermati subito e indossa il casco. Inoltre, il casco deve calzare perfettamente e deve aderire saldamente alla testa.

## STRUTTURA DEL CASCO AFX

Questo casco è stato progettato e messo a punto in base agli STANDARD DOT e ECE che soddisfano o superano gli standard di sicurezza per i caschi DOT FMVSS 218 (USA/CANADA), ECE 22-05 (EUROPA).

Consulta lo schema riportato di seguito per prendere confidenza con i nomi e i termini specifici utilizzati su questo casco prima di tentare di riparare o sostituire sue parti.

① VISIERA

② SCHERMO

③ SCHERMO INTERNO

④ SGANCIO RAPIDO

⑤ CINTURINO DI FISSAGGIO

⑥ REGOLAZIONE SCHERMO INTERNO

⑦ VENTILAZIONE

⑧ CALOTTA ESTERNA

⑨ IMBOTTITURA INTERNA EPS

⑩ FODERA INTERNA

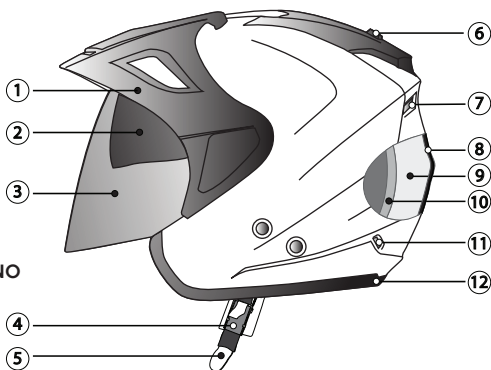

⑪ VENTILAZIONE

⑫ GUARNIZIONE DELLA BASE

**NON MODIFICARE IL CASCO.** Per preservare la completa efficacia di questo casco, ti sconsigliamo di alterarne la struttura interna o esterna o i relativi componenti. Molti adesivi e vernici possono danneggiare il casco e renderlo inefficace, anche se il danno non risulta visibile all'utente. Ti suggeriamo quindi di non verniciare o applicare adesivi sul casco.

# INDOSSARE IL CASCO AFX IN MODO CORRETTO

## TABELLA DI MISURA DEI CASCHI

<b>XS</b> 6 <sup>3</sup> / <sub>4</sub> - 6 <sup>7</sup> / <sub>8</sub> hat 21 <sup>1</sup> / <sub>4</sub> - 21 <sup>5</sup> / <sub>8</sub> '' 54 - 55 cm	<b>S</b> 7 - 7 <sup>1</sup> / <sub>8</sub> hat 22 - 22 <sup>7</sup> / <sub>16</sub> '' 56 - 57 cm	<b>M</b> 7 <sup>1</sup> / <sub>4</sub> - 7 <sup>3</sup> / <sub>8</sub> hat 22 <sup>13</sup> / <sub>16</sub> - 23 <sup>1</sup> / <sub>4</sub> '' 58 - 59 cm
<b>L</b> 7 <sup>1</sup> / <sub>2</sub> - 7 <sup>5</sup> / <sub>8</sub> hat 23 <sup>5</sup> / <sub>8</sub> - 24'' 60 - 61 cm	<b>XL</b> 7 <sup>3</sup> / <sub>4</sub> - 7 <sup>7</sup> / <sub>8</sub> hat 24 <sup>3</sup> / <sub>8</sub> - 24 <sup>13</sup> / <sub>16</sub> '' 62 - 63 cm	<b>XXL</b> 8 - 8 <sup>1</sup> / <sub>8</sub> hat 25 <sup>3</sup> / <sub>16</sub> - 25 <sup>5</sup> / <sub>8</sub> '' 64 - 65 cm

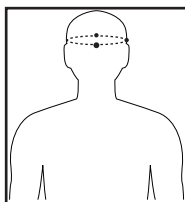

MISURA DELLA TESTA

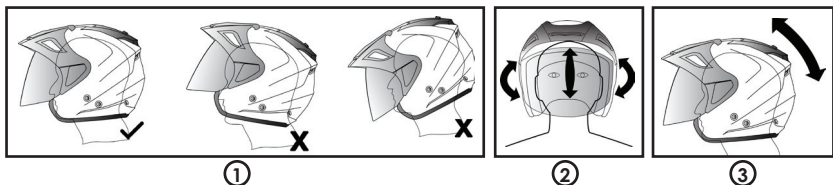

Stabilisci la circonferenza della parte più larga della tua testa utilizzando un metro da sarta. Generalmente, la parte più larga della testa corrisponde alla zona situata 2,5cm (1") sopra gli occhi e le orecchie. Tuttavia, prima di consultare le nostre tabelle delle misure, ti suggeriamo di effettuare la misurazione in più punti al di sopra e al di sotto di questa linea per stabilire il valore maggiore. Ti suggeriamo inoltre di provare anche un casco di una misura più piccola e uno di una misura più grande rispetto alle indicazioni fornite dalla tabella. Nessun casco è in grado di proteggerti se lo senti troppo scomodo.

I caschi devono essere stretti ma non devono fare male. Indossa il casco tenendo il cinturino del sottomento al di fuori, tira il casco verso il basso sulla testa facendo attenzione che il cinturino non finisca all'interno. Un casco della misura corretta risulterà aderente con una pressione alquanto omogenea nelle aree laterali e superiore della testa. Sui caschi più moderni, la protezione è realizzata per risultare all'inizio un po' aderente, ma dopo avere indossato il casco per varie ore, questo si adatterà perfettamente alla forma della testa.

Se non sai come deve stare un casco, chiedi consigli a chi ha più esperienza di te o direttamente o al negozio dove l'hai acquistato. Di norma, il casco non deve potersi muovere intorno alla testa senza tirare la pelle. Un casco non aderente, non solo risulta pericoloso ma può anche essere rumoroso e scomodo da indossare. La maggior parte dei centauri commette l'errore di comprare un casco troppo grande. **IMPORTANTE:** quando provi un casco, assicurati di chiudere il cinturino del sottomento in modo corretto, quindi accertati di non poter togliere il casco dalla testa quando è allacciato. Il casco non deve essere lento al punto da poter ruotare liberamente in avanti o all'indietro e quindi da poter essere tolto con il cinturino del sottomento allacciato

Nessun casco può proteggere chi lo indossa da tutti gli impatti, possibili o prevedibili. Un casco può proteggere solo la parte di testa da esso coperta. Per ottenere la massima protezione, il casco deve essere sempre indossato con il cinturino del sottomento allacciato correttamente. Il mancato rispetto di queste istruzioni, delle istruzioni stampate nel casco e di quelle presenti nel manuale dell'utente può causare lo scivolamento del casco in caso di incidente, con conseguenti gravi lesioni alla testa o persino la morte. Guidare motocicli, scooter, quad e motoslitte è divertente, ma può anche essere pericoloso. Noi di AFX promuoviamo la guida responsabile e mai al di sopra delle proprie capacità.

## **SISTEMA DI RITENUTA DEL CINTURINO DEL SOTTOMENTO: SGANCIO RAPIDO**

**IMPORTANTE:** assicurati sempre di allacciare il cinturino del sottomento quando indossi il casco. Prima di metterti alla guida, allaccia correttamente il cinturino e verifica che il casco non si possa togliere.

Il casco deve essere indossato o allacciato in modo da non ruotare liberamente sulla parte anteriore o posteriore e non poter essere sfilato quando il cinturino del sottomento è allacciato.

Il sistema di ritenuta a sgancio rapido presente su questo casco consente di indossare e sfilare agevolmente il casco anche quando si indossano dei guanti piuttosto grossi; offre inoltre numerose possibilità di regolazione per la natura stessa di blocco del sistema. Prima di metterti alla guida, accertati di non poterti sfilare il casco quando il sistema di ritenuta a sgancio rapido è regolato in base alle tue esigenze.

Quando devi fissare per la prima volta il sistema di ritenuta a sgancio rapido, ti consigliamo di seguire queste importantissime istruzioni di sicurezza. Ti consigliamo di prenderti il tempo necessario per eseguire questa procedura, una volta completata e impostata correttamente questa offrirà un modo sicuro e comodo per fissare il casco. Probabilmente dovrai fare più tentativi prima di trovare la giusta vestibilità in base alle tue esigenze ma, una volta impostato correttamente, il sistema di ritenuta a sgancio rapido offre una soluzione rapida e comoda per essere certo che il casco sia allacciato in modo sicuro e corretto.

Indossa il casco e inserisci l'aletta di arresto nel dispositivo di arresto. Ti consigliamo di inserire la linguetta più di metà della sua lunghezza (avvertendo 5 clic) nel dispositivo di arresto per impostare inizialmente la vestibilità in base alle tue esigenze. Se la cinghia non presenta una lunghezza sufficiente, attieniti alle illustrazioni per vedere come allungare la cinghia. Oppure, se la cinghia è troppo lunga, puoi accorciarla seguendo le istruzioni.

Non tagliare mai la cinghia per accorciarla. Una volta regolata correttamente, la linguetta di blocco a sgancio rapido deve essere inserita nel dispositivo di arresto per più di metà della sua lunghezza (avvertendo 5 clic) una volta indossato il casco. La parte in eccesso della cinghia può essere fatta passare nuovamente attraverso la fibbia che, a sua volta, può essere posizionata in un punto qualunque sulla parte laterale della cinghia del dispositivo di arresto per consentire il fissaggio di una porzione di cinghia di lunghezza maggiore.

La fibbia della cinghia non deve essere mai rimossa da questo sistema. Durante la regolazione della cinghia attraverso la fibbia, accertati di nuovo di averla infilata correttamente in modo che l'estremità libera sia esterna e venga fatta passare nel modo previsto dalle illustrazioni. La funzione della fibbia della cinghia è di bloccare la cinghia nella linguetta del dispositivo di arresto. L'uso non corretto della fibbia della cinghia nel modo previsto può causare la mancata protezione del sistema di ritenuta e del casco in caso di incidente.

Ti invitiamo a consultare la figura per accertarti di aver chiuso correttamente la cinghia e, come sempre, non metterti alla guida se il cinturino del sottomento e il sistema di ritenuta non sono chiusi correttamente. E prima di metterti alla guida, accertati di aver controllato di non riuscire a sfilare il casco quando il sistema di ritenuta a sgancio rapido è regolato in base alle tue esigenze.

Per rimuovere il cinturino del sottomento, sollevare la linguetta sul dispositivo di aggancio come illustrato nella figura riportata di seguito. Ora puoi fare uscire la linguetta del dispositivo di arresto. Accertati sempre di aver controllato il cinturino del sottomento e il sistema di ritenuta prima e dopo aver guidato: se il cinturino o il sistema di ritenuta presenta segni di usura, ti consigliamo di sostituire immediatamente il casco. Non guidare mai con un casco usurato, danneggiato o senza parti del cinturino del sottomento o del sistema di ritenuta. Non modificare in alcun modo il cinturino del sottomento o il sistema di ritenuta.

### AGGANCIARE CINTURINO

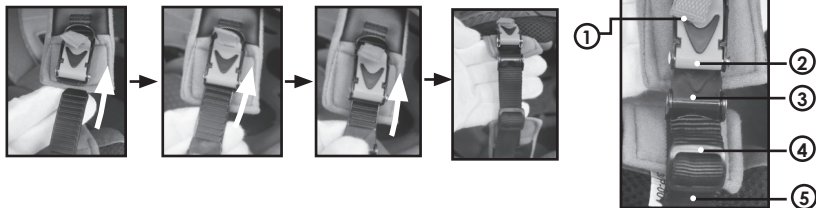

### SGANCIARE CINTURINO

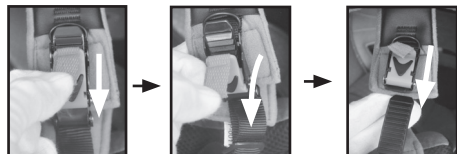

- ① LINGUETTA DI SGANCIO
- ② INSERIMENTO CRICCHETTO
- ③ CRICCHETTO
- ④ FIBBIA CINTURINO
- ⑤ CINTURINO DI FISSAGGIO

Accertati che il cinturino del sottomento e il sistema di ritenuta siano sempre allacciati nel modo sopra indicato. Non allacciare il cinturino secondo le presenti istruzioni potrebbe essere causa di lesioni gravi o morte.

## **INTERNO: CUSCINETTI PER LE GUANCE E IMBOTTITURA**

I cuscinetti per le guance e le imbottiture dei caschi AFX sono realizzati in nylon anti-microbico e ipoallergenico, la maggior parte del quale rimovibile e lavabile.

La misura del casco si basa su una combinazione di quattro fattori: dimensione esterna della calotta, spessore interno in polietilene espanso (EPS), spessore dell'imbottitura e spessore del cuscinetto per le guance. La vestibilità del casco può essere personalizzata sostituendo i cuscinetti per le guance esistenti con cuscinetti più sottili (per un maggiore comfort) o con cuscinetti più spessi (per una maggiore aderenza). La vestibilità del casco può essere personalizzata sostituendo l'imbottitura esistente con una più sottile (per un maggiore comfort) o con una più spessa (per una maggiore aderenza).

Ti consigliamo di consultare la scheda di compatibilità per i cuscinetti per le guance, l'imbottitura e la calotta e ricordati che queste parti possono essere sostituite solo con componenti della stessa misura.

E se decidi di personalizzare la vestibilità del tuo casco, ricorda di osservare le istruzioni riportate sopra nella guida per un utilizzo corretto.

<b>DIMENSIONE CALOTTA &amp; IMBOTTITURA INTERNA</b>	<b>XS</b>	<b>S</b>	<b>M</b>	<b>L</b>	<b>XL</b>	<b>XXL</b>
<b>SPESORE IMBOTTITURA PER LE GUANCE(MM)</b>	48	44	40	36	32	28
<b>SPESORE FODERA INTERNA (MM)</b>	12	10	12	8	8	4



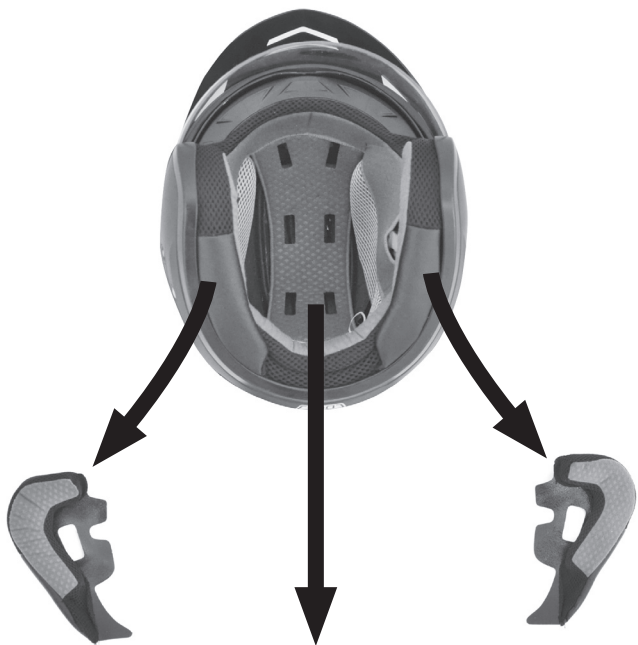

**IMBOTTITURA PER LA  
GUANCIA**

**IMBOTTITURA PER LA  
GUANCIA**



**FODERA INTERNA**

# ESTRAZIONE DELL'IMBOTTITURA

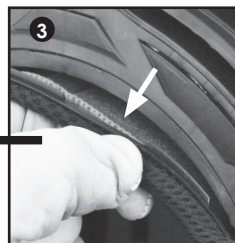
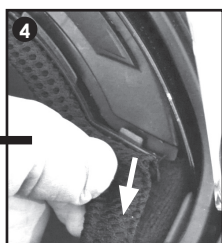
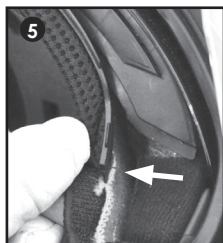
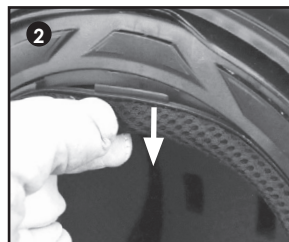
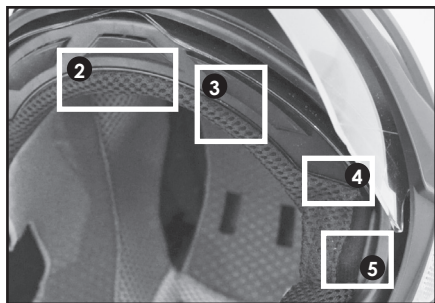
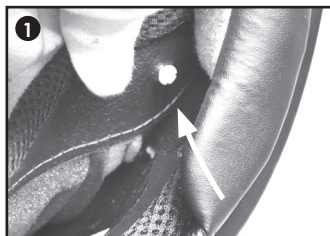
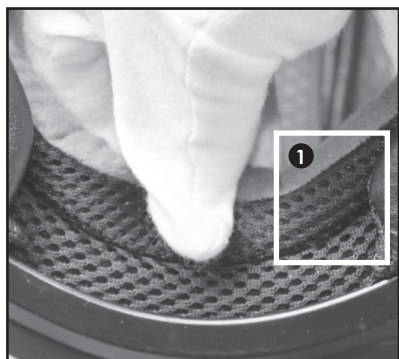

Per montare nuovamente l'imbottitura, devi invertire i passaggi da

# RIMOZIONE DEI CUSCINETTI PER LE GUANCE

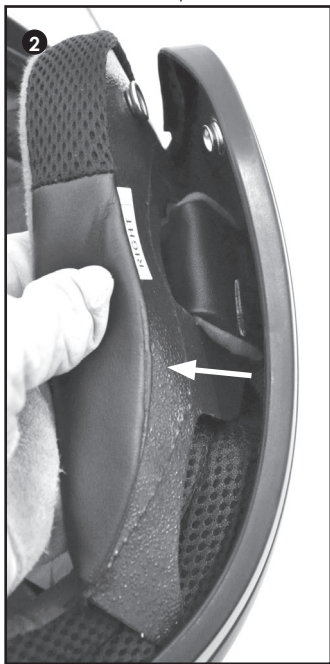
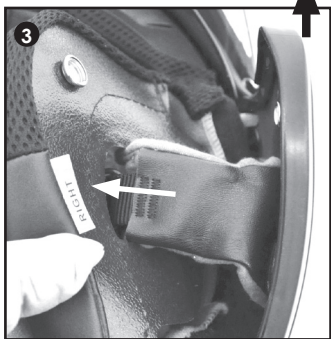
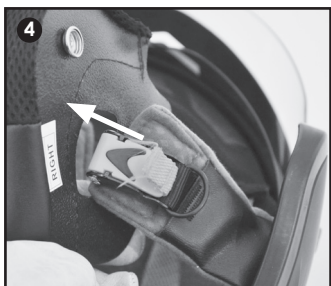
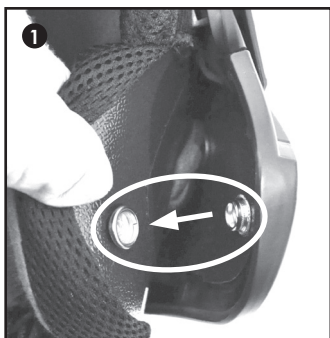
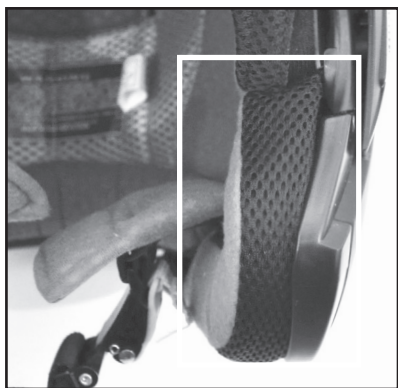

Per installare nuovamente i cuscinetti per le guance, devi invertire i passaggi da 1 a 4.

# SMONTAGGIO DELLA VISIERA

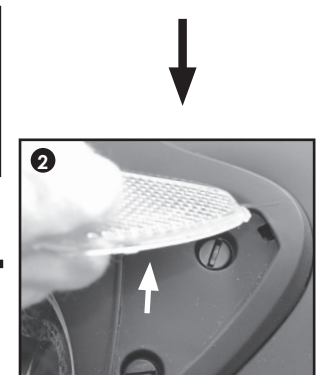
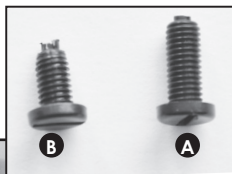
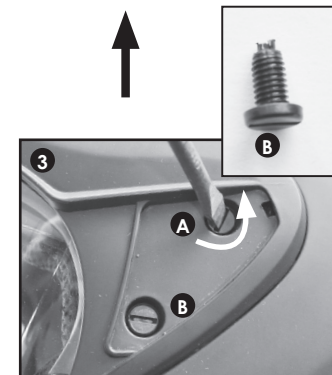
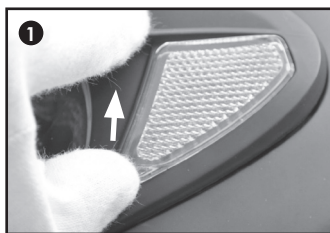
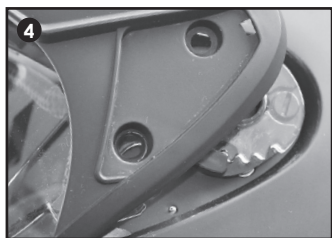

Per reinstallare la visiera, inverti i punti 1-4.

# SMONTAGGIO DELLO SCHERMO

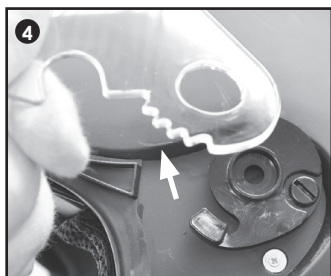
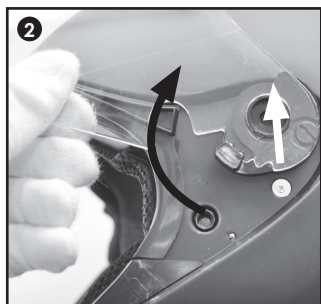
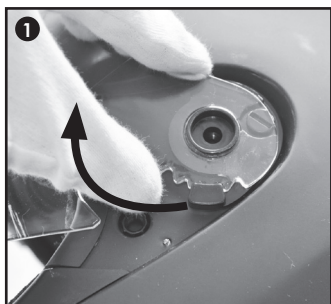
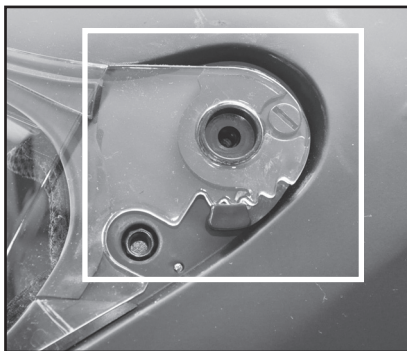

Per reinstallare lo schermo, inverti i punti 1-4.

# INSTALLAZIONE DELLA VISIERA

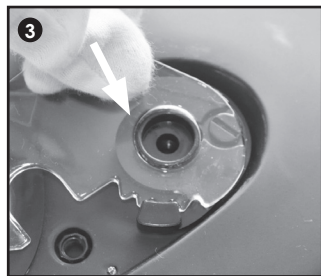
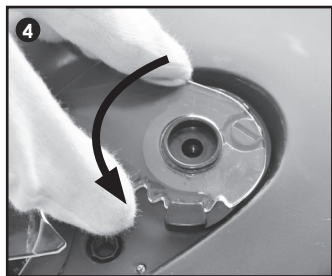
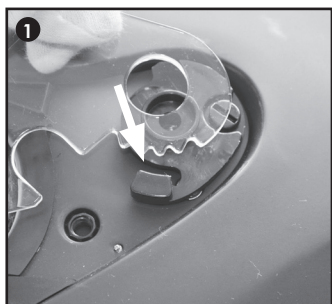
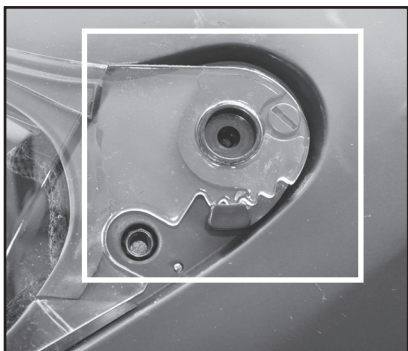

# RIMOZIONE/INSTALLAZIONE COPERCHIO LATERALE

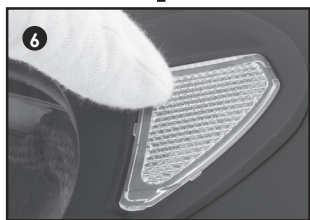
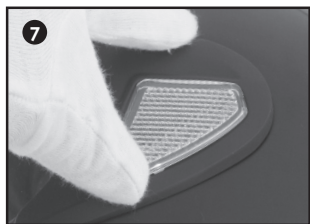
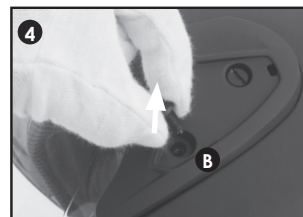
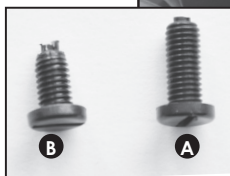
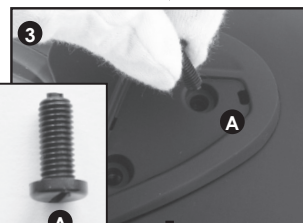

Per reinstallare i coperchi laterali, inverti i punti 1-7.

# SMONTAGGIO DELLO SCHERMO INTERNO

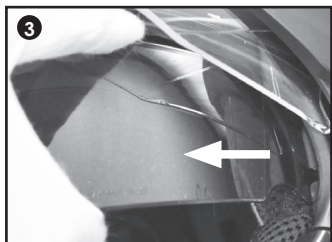
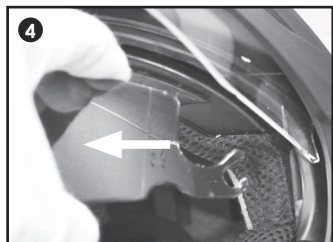
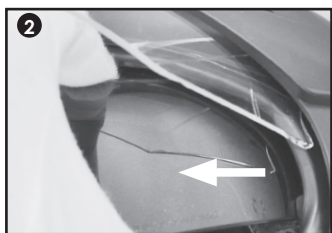
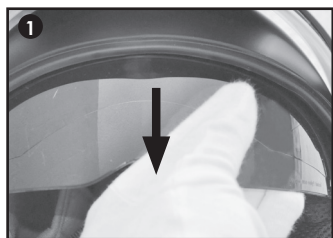
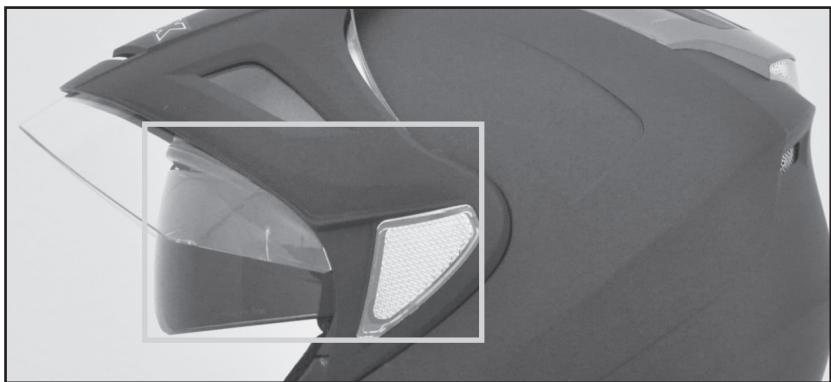



# INSTALLAZIONE DELLO SCHERMO INTERNO

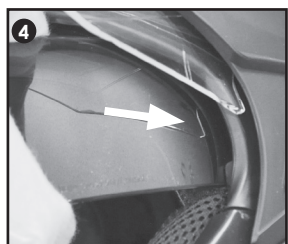
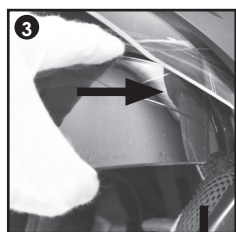
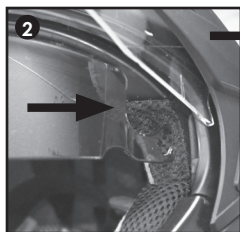
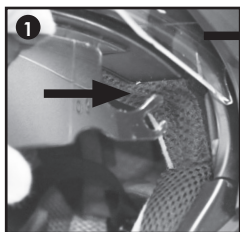
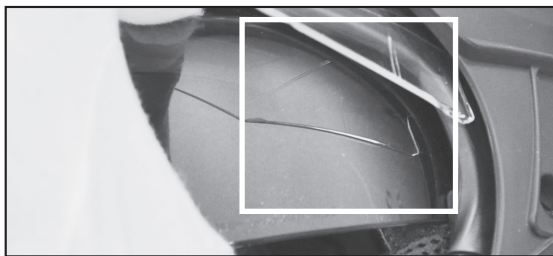

# APRIRE/CHIUDERE LO SCHERMO INTERNO

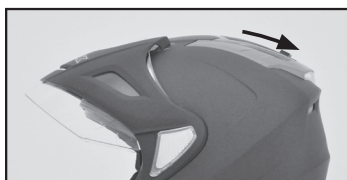
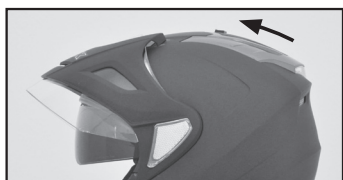

# APRIRE/CHIUDERE LO SCHERMO

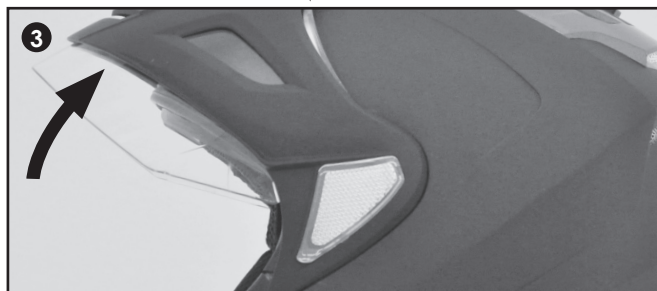
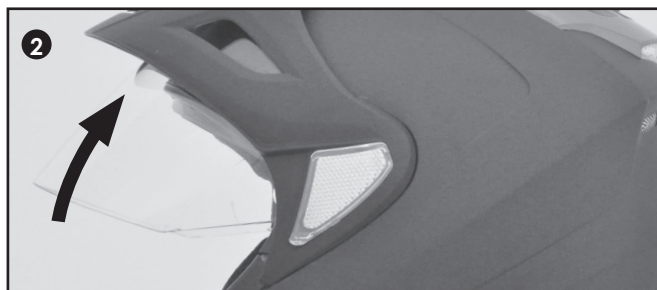
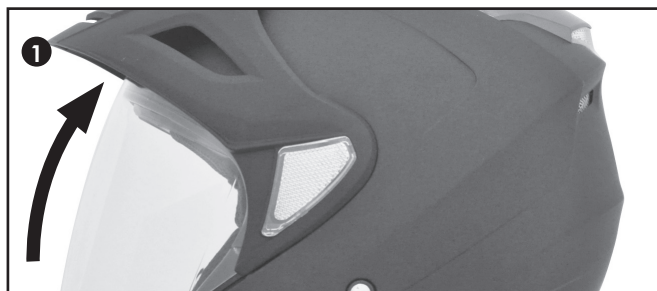

Per chiudere lo schermo, inverti i punti 1-3

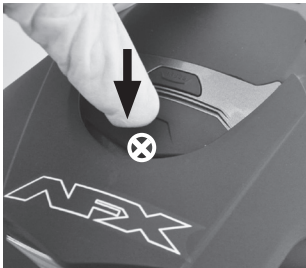
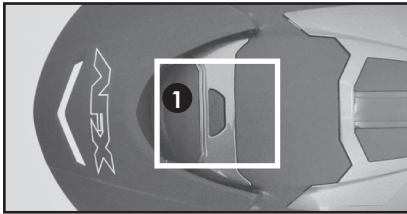

1



# CURA E PULIZIA DEL CASCO AFX

Ti invitiamo a pulire il rivestimento del casco solo con acqua e sapone delicato. Ti invitiamo a utilizzare una soluzione di sapone liquido delicato e acqua calda ma non bollente. Dopo aver pulito l'interno del casco, risciacqualo con acqua fredda e lascialo asciugare all'aria a temperatura ambiente. Temperature elevate e detersivi per la pulizia possono danneggiare il rivestimento. Il casco subirà danni, seppur non visibili, in caso di utilizzo dei seguenti prodotti:

- Benzina, olio, solventi e liquidi a base di petrolio
- Detersivi abrasivi o aggressivi
- Vernici
- Adesivi

È possibile applicare cere per automobili sulle superfici verniciate della calotta del casco per proteggerne la finitura. Ti invitiamo a utilizzare esclusivamente una cera adatta alle finiture verniciate. Se il casco è dotato di visiera, ti consigliamo di utilizzare solo acqua calda e sapone delicato e di asciugarla con un panno morbido. Non utilizzare mai fazzoletti o asciugamani di carta per pulire la visiera. Inoltre, non utilizzare mai alcun tipo di detersivo per vetri disponibile in commercio. È tuttavia possibile utilizzare determinati detersivi per vetri se approvati anche per le superfici in plastica. Prima di indossare il casco, ti consigliamo di leggere tutte le etichette di avvertenza riportate sulle soluzioni protettive o sui detersivi.

# CONSERVAZIONE DEL CASCO AFX

Quando non utilizzato, conserva il casco in un luogo sicuro. Ti consigliamo di conservare il casco nella borsa protettiva fornita in dotazione; in alternativa, è disponibile a richiesta una borsa aerata. Per ulteriori informazioni, consulta il sito [Web.afxhelmets.com](http://Web.afxhelmets.com)

I caschi sono resistenti, ma per preservarne la struttura e l'integrità, devono essere protetti se inutilizzati a lungo. Tuttavia, ti consigliamo di non lasciare inutilizzato il casco a lungo perché è più divertente essere in sella che andare a piedi. Ogni tentativo di installazione o sostituzione di visiera deve essere eseguito a temperatura ambiente, in quanto tale elemento può rompersi a temperature molto basse.

Ricorda che gli animali vengono attirati dai sali prodotti dalla sudorazione e potrebbero essere invogliati a masticare il rivestimento del casco e i cuscinetti per le guance. Questo succede davvero, quindi ti conviene dare ai tuoi animali il loro cibo e non il casco.

# AVVERTENZE IMPORTANTI PER LA SICUREZZA

AFX consiglia di non utilizzare più il casco in caso di urto sulla calotta, anche laddove il danno fisico non risultasse visibile. Un casco è progettato per deformarsi in caso di incidente e assorbire l'energia dell'impatto e non deve essere mai più riutilizzato in quanto la sua capacità di protezione potrebbe risultare compromessa. Anche nel caso in cui un casco cada accidentalmente per terra o su un'altra superficie dura potrebbe subire danni non visibili agli occhi di chi lo deve indossare.

Se sospetti che l'integrità del casco sia stata in qualche modo compromessa, smetti immediatamente di indossarlo e comprane un altro. Se hai dei dubbi su cosa fare, contatta AFX tramite il nostro sito Web. [Afxhelmets.com](http://Afxhelmets.com)

È inoltre importante sapere che indossare un casco non ti rende indistruttibile e ti invitiamo pertanto di guidare in modo responsabile e mai al di sopra delle tue capacità.

## SOSTITUZIONE RACCOMANDATA DEL CASCO

La durata prevista di un casco AFX è pari a 4-5 anni di uso stagionale e diminuisce all'aumentare del suo utilizzo. Come forse immagini, i caschi utilizzati in gara, ad esempio per le competizioni su strada e in fuoristrada, tendono ad avere una vita molto più breve. Più un casco viene esposto ad agenti atmosferici, oli per il corpo e sudore, più rapidamente si userà. Nella maggior parte dei casi, la protezione del casco sarà il primo componente a rovinarsi e, di conseguenza, rappresenta un valido indicatore di sostituzione del casco. Se non sei sicuro che il tuo casco debba essere sostituito, contatta AFX tramite il nostro sito Web. [Afxhelmets.com](http://Afxhelmets.com)

Grazie per aver acquistato un casco AFX e aver dedicato del tempo alla lettura di questo manuale dell'utente. Dal nostro sito Web [afxhelmets.com](http://afxhelmets.com) puoi scaricare una copia di questo manuale e altre informazioni utili.

# NOTES

# NOTES



**AFXHELMETS.COM**

**PRINTED IN TAIWAN**